

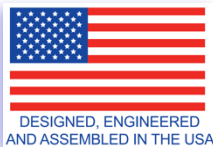

900 Series Multi-Parameter Monitor/Controller™

Operation Manual



REVISION HISTORY:

Rev.	Date Released	Description of Change
r03-20	01-MAR-2020	Initial Release

To download the most up to date version of this manual go to www.myronl.com

IDENTIFICATION RECORDS

Model Number: _____

Serial Number: _____
(This number appears on the label located on the side of the instrument.)

Date of Purchase: _____
(This is the warranty start date.)

Installation Location: _____

Asset ID (user assigned): _____

COPYRIGHT INFORMATION

This document is copyrighted by Myron L[®] Company and shall not be reproduced or copied without expressed written authorization from Myron L[®] Company.
The information contained within this document is subject to change without notice. Myron L[®] Company does not guarantee the accuracy of the information.



ESSENTIAL INFORMATION

1. Important User Information:







In no event will Myron L[®] Company be responsible or liable for indirect or consequential damages resulting from the use or application of this equipment.

The examples and diagrams in this manual are included solely for illustrative purposes. Because of the many variables and requirements associated with any particular installation, Myron L[®] Company cannot assume responsibility or liability for actual use based on the examples and diagrams.

Throughout this manual, when necessary, we use notes to make you aware of safety considerations.

Alert	Meaning
	Signifies an important note.
CAUTION	Identifies information about practices that should be taken to avoid the potential for damage to, or loss of use of, the 900 Series Monitor/Controller or other equipment or avoid a safety hazard to the user.
WARNING	Identifies information about practices or circumstances that can cause a significant likelihood of damage to, or loss of use of, the 900 Series Monitor/Controller or other equipment, personal injury or death, property damage, or economic loss.
	Identifies information that is critical for successful application and understanding of the product.
	Indicates a possible electric shock hazard may exist.

PLEASE READ and COMPREHEND ALL WARNINGS, CAUTIONS and ADVISEMENTS CONTAINED WITHIN THIS MANUAL. Failure to comply is beyond the responsibility of the Myron L[®] Company.

 WARNING	Ensure power is off while installing electrical equipment. If monitor/controller is installed, ensure the power is off before servicing. Failure to do so could cause damage to the instrument and could be harmful or fatal to personnel. Only qualified personnel should install or service electrical equipment. Install all wiring to comply with applicable electrical codes.
 WARNING	This Instrument contains NO OPERATOR SERVICEABLE PARTS!
 WARNING	This instrument may not be used to measure categories, II, III, or IV (IEC 61010-2-30 Annex AA) Main Power Circuits. It has been designed without a rated measuring category and may only be used at direct voltage circuits less than or equal to the voltage levels specified in the technical specifications for each input or output.
 WARNING	Operating safety is no longer assured if the instrument is modified or altered in any way. This instrument may only be opened by authorized service personnel. Operating the instrument at a higher voltage than specified in the technical specifications may destroy or permanently damage it.
 WARNING	The 900 Series Multi-Parameter Monitor/Controllers operate on 12-24 VDC or 24 VAC. Before applying power ensure the input power supply is correct. Failure to do so is beyond the responsibility of the Myron L [®] Company.
 CAUTION	All environmental specifications listed in this manual apply equally to the 900 Series Multi-Parameter Monitor/Controller and all of its parts.
	WARNING! These products can expose you to chemicals including Di(2-ethylhexyl)phthalate (DEHP), which is known to the State of California to cause cancer and birth defects or other reproductive harm. For more information go to www.P65Warnings.ca.gov .

2. Trademark Information:

Brand or product names are trademarks or registered trademarks of their respective owners.

- Myron L® is a registered trademark of the Myron L® Company
- 900 Series Multi-Parameter Monitor/Controller™ and 442 Natural Water Standard™ are trademarks of the Myron L® Company.

3. FCC Part 15 Statement:

This equipment has been tested and found to comply with the limits for a Class A digital device, pursuant to FCC Part 15, Subpart B.

- These limits are designed to provide reasonable protection against harmful interference when the equipment is operated in a commercial environment.
- This equipment generates, uses, and can radiate radio frequency energy and, if not installed and used in accordance with the instruction manual, may cause harmful interference to radio communications.
- Operation of this equipment in a residential area is likely to cause harmful interference in which case the user will be required to correct the interference at his or her own expense.

4. EN / IEC / EU Compliance:

The Myron L® Company declares under our sole responsibility that this instrument complies with the requirements, principal elements and objectives of the following:

- EN 61326-1 – Electrical Equipment for Measurement and Laboratory Use, EMC requirements.
- IEC 61010-1 – Safety Requirements for Electrical Equipment for Measurement, Control, and Laboratory use.
- 2015/863/EU – Restrictions on Hazardous Substance (RoHS 3) Directive.

5. CAUTION – European Users:

This is a Class A product. In a domestic environment this product may cause radio interference in which case the user may be required to take adequate measures.

6. WARNING – Electromagnetic Compatibility:

The connection of non-shielded equipment interface cables to this equipment will invalidate FCC EMI and European Union EMC compliance and may result in electromagnetic interference and/or susceptibility levels which are in violation of regulations which apply to the legal operation of this device. It is the responsibility of the system integrator and/or user to apply the following directions, which relate to installation and configuration:

- All interface connections must be made with shielded cables. Shields must be connected as described in this manual.
- Protective measures for power and interface cables as described within this manual must be applied.
- Do not leave cables connected to unused interfaces or disconnected at one end.
- Changes or modifications to this device not expressly approved by the manufacturer could void the user's authority to operate the equipment.

7. Disposal:

	<p>DISPOSAL!</p> <p>At the end of its service life, the device and any accessories do not belong in the trash. These items are made from materials that can be reclaimed through recycling.</p> <p>Dispose of the device, accessories, and packaging material as required by regulations and in an environmentally sound manner!</p> <p>The local and country-specific laws and regulations for handling and disposing of waste must be observed.</p>
---	--

HOW TO USE THIS MANUAL:

The 900 Series Multi-Parameter Monitor/Controller Operation Manual was written to be most useful to all users, from novice to skilled professional.

Most functions are programmed to prompt you through required settings, simply make selections and tap the **NEXT** button. Subsequent changes to a function's settings will allow you to select only those fields you wish to change.



Read this operating manual before putting the device into service.
Keep the operating manual at a location that is readily accessible to all users.

The basic setup steps:

- Install the base unit
- Install all sensors
- Connect all sensors, inputs, and output wiring to base unit
- Power up the 900 and go through the Initial Setup procedure
- Program Detailed Operating Settings custom to your application
- Calibrate as necessary

If you have any questions regarding this manual or need additional information, please contact our Technical Sales personnel at techquestions@myronl.com or call 760-438-2021.

Table of Contents

- I. INTRODUCTION10**
 - A. Scope.....10**
 - B. Benefits10**
 - C. Applications.....10**
 - D. Features.....10**
- II. SPECIFICATIONS11**
- III. ORDERING INFORMATION.....17**
 - A. 900 Series Models17**
 - 1. 900 Series Model Features17
 - B. Sensors18**
 - 1. Conductivity/Resistivity/TDS/Salinity Sensors.....18
 - 2. Pre-amplified pH/ORP Sensors (for use with the 900 Series pH/ORP Input).....19
 - 3. BNC Style pH/ORP Sensors (for use with the 900 Series mV Input).....19
 - 4. Temperature Sensors20
 - 5. Flow Meter20
- IV. INSTALLATION21**
 - A. Unpacking and Inspection of Equipment21**
 - B. Installing the 900 Series Multi-Parameter Monitor/Controller.....22**
 - 1. Select a Mounting Site.....23
 - 2. Panel Mounting.....23
 - C. Installing Sensors.....26**
 - 1. Installing Conductivity/Resistivity/TDS/Salinity Sensors.....26
 - 2. Installing pH/ORP Sensors.....27
 - D. Electrical Installation28**
 - 1. Wiring Inputs and Outputs to the Connectors.....29
 - 2. Install Ferrite Bead on Power Cable.....29
 - 3. Connecting Inputs, Outputs, and Power to the 90030
 - 4. Back Panel Connector Locations.....30
- V. INITIAL SETUP31**
 - A. Date and Time31**
 - B. Location.....32**
 - C. Set Up Password Security32**
 - D. Enable/Disable Input Channels.....33**
 - E. Screen Layout34**
- VI. DETAILED OPERATING SCREEN.....36**
- VII. DETAILED OPERATING SETTINGS37**
 - A. Conductivity, Resistivity, TDS or Salinity.....37**
 - 1. Sensor Settings37
 - 2. Select Measurement Type38
 - 3. Select Solution Type.....38
 - B. pH/ORP (Pre-amplified)39**
 - 1. Sensor Settings, pH/ORP.....39
 - 2. Select Measurement Type39
 - C. mV Input (BNC)40**

1.	Select Measurement Type	40
D.	RTD Temperature Input.....	41
E.	Temperature Unit of Measure.....	41
F.	4-20 mA Input	42
1.	Select Measurement Type	42
2.	Measurement Settings, 4-20 mA	42
G.	Flow / Pulse Input.....	43
1.	Sensor Settings, Flow/Pulse Input.....	43
2.	Select Measurement Type	43
3.	Volume Reset	44
H.	Flow Switch Input.....	44
I.	Relays and Alarms	44
1.	Relay Wiring Options	45
2.	Relay Settings	46
3.	Alarm Settings	47
4.	Reset Latching Alarms.....	48
5.	Testing Relays and Alarms	49
6.	Relay/Alarm OVERRIDE Mode.....	49
7.	Relay/Alarm Settings Reset	50
8.	Relay/Alarm Visual Indicators	50
VIII.	DETAILED SYSTEM SETTINGS	52
A.	Date and Time	52
B.	Location.....	52
C.	Passwords and Security	53
1.	Administrator Password Setup.....	53
2.	Operator Access Setup.....	54
3.	Operator Password Setup	55
4.	Change Administrator Password	55
5.	Change Operator Password.....	55
6.	Reset Administrator Password.....	56
7.	Reset Operator Password	56
D.	Input Channels.....	56
1.	Enable/Disable Input Channels.....	56
IX.	DISPLAY SETTINGS.....	57
1.	Screen Layout	57
2.	All Channels Screen Layout.....	59
3.	Locking/Unlocking the Single Channel Screen.....	59
4.	Screen Configuration	59
5.	Brightness	60
6.	Night Mode.....	60
7.	Timeout Settings	61
X.	ADVANCED SETTINGS.....	62
A.	0-10V Recorder Output.....	62
1.	Programming the 0-10V Recorder Output	62
2.	Voltage Divider	63
B.	4-20mA / 0-20mA Output (Model 900M-3C only).....	63
C.	Derived Measurement.....	65

1.	Percent (%) Rejection.....	65
D.	User Mode Tempco and Ratio Settings.....	66
1.	Selecting the User Mode Solution Type.....	66
2.	Disable or Customize Temperature Compensation.....	67
3.	Enter Custom Conductivity to TDS Ratio.....	67
E.	Factory Reset.....	67
XI.	CALIBRATION.....	68
A.	Conductivity, TDS, or Salinity Calibration.....	68
1.	Wet Calibration with Standard Solution.....	68
2.	Transfer Standard Method of Calibration.....	69
3.	FAC CAL (Reloading Factory Calibration).....	69
B.	Resistivity Calibration.....	70
1.	Transfer Standard Method of Calibration.....	70
2.	Sensor Substitute.....	71
3.	FAC CAL (Reloading Factory Calibration).....	72
C.	pH Calibration.....	73
1.	pH Calibration with Buffer Solution(s).....	73
2.	Transfer Standard Calibration.....	75
3.	FAC CAL (Reloading Factory Calibration).....	76
D.	ORP Calibration.....	77
1.	ORP Calibration with Standard Solution.....	77
2.	Transfer Standard Calibration.....	77
3.	FAC CAL (Reloading Factory Calibration).....	78
E.	Temperature Calibration.....	79
1.	Wet Calibration.....	79
2.	Sensor Substitute, Temperature.....	80
3.	FAC CAL (Reloading Factory Calibration).....	81
F.	4-20mA Output Calibration.....	82
1.	Electronic Calibration.....	82
2.	FAC CAL (Reloading Factory Calibration).....	83
G.	0-10 VDC Recorder Output Calibration.....	83
1.	Electronic Calibration.....	83
2.	FAC CAL (Reloading Factory Calibration).....	84
XII.	REFERENCE INFORMATION.....	84
A.	Temperature Compensation (Tempco) of Aqueous Solutions.....	84
1.	Standardized to 25°C.....	84
2.	Tempco Variation.....	84
3.	Example of 2 Different Solution Selections and the Resulting Compensation.....	85
4.	Chart of Comparative Error.....	85
5.	Other Solutions.....	85
B.	Conductivity Conversion to Total Dissolved Solids (TDS).....	85
1.	How it's Done.....	85
2.	Solution Characteristics.....	86
3.	When does it make a lot of difference?.....	86
C.	Temperature Compensation (Tempco) and TDS Derivation.....	86
1.	Conductivity Characteristics.....	86
2.	Finding the Tempco of an Unknown Solution.....	87
3.	Finding the TDS Ratio of an Unknown Solution.....	87

D. pH, ORP and Temperature Relationships.....	87
1. pH.....	87
2. ORP/Oxidation-Reduction Potential/REDOX.....	88
3. pH and ORP SENSOR CAUTIONS	89
E. Relay and Alarm Trigger, Set Point and Hysteresis Functionality.....	90
XIII. MAINTENANCE	92
A. 900 Series Multi-Parameter Monitor/Controller Base Unit.....	92
1. Cleaning the Display	92
2. Calibrating the Display Touch Screen	92
B. Sensor Care.....	92
1. pH and ORP Sensors	92
2. Conductivity, TDS, Resistivity, and Salinity Sensors	93
XIV. TROUBLESHOOTING.....	94
A. Troubleshooting Chart	94
B. Frequently Asked Questions.....	94
C. System Overview Screen.....	95
XV. ACCESSORIES.....	96
A. Standard Solutions and Buffers	96
1. Conductivity/TDS Standard Solutions	96
2. pH and ORP Buffer Solutions	96
3. Ordering Information	97
B. NIST Certification	97
C. Resistivity Sensor Substitutes	97
D. Temperature Sensor Substitutes	97
E. Alarms.....	98
1. Terminal Block Locations	98
2. Remote Alarm - RA™	98
3. Piezo Electric Alarm.....	100
4. Connecting to Your Own Alarm	101
F. Mounting Brackets	102
G. Power Adapter.....	102
1. Specifications	102
XVI. GLOSSARY	103
XVII. WARRANTY	105

I. INTRODUCTION

Myron L® Company's new 900 Series Multi-Parameter Monitor/Controllers combine accuracy, reliability, simplicity, and flexibility. The easy to read, 3.5" color TFT display with resistive touch-screen and user intuitive GUI (Graphical User Interface) allows easy and complete programmability of the instrument all from the LCD touch screen. These highly accurate instruments have the ability for simultaneous monitoring and controlling of multiple inputs/outputs.

Since temperature compensation (TC) is at the heart of accurate water measurement, all 900 Series Monitor/Controllers feature a highly refined and precise TC correction algorithm based on years of proven experience. Conductivity, TDS, Resistivity, Salinity, and pH readings are corrected to 25°C. The TC feature may be turned off to conform to USP requirements.

A. Scope

This operation manual provides the information necessary to install, customize settings, operate, and maintain the Myron L® Company's 900 Series Multi-Parameter Monitor/Controllers.

B. Benefits

- Affordable
- Ease of Operation
- Low Maintenance
- Ensure Product Quality
- Prevent Equipment Damage
- Reduce Waste
- Protect the Environment

C. Applications

- Power Plants
- Agriculture
- Waste Water Management
- Boilers & Cooling Towers
- Reverse Osmosis
- Deionization (DI)
- Electronics
- Pharmaceuticals
- Laboratories
- Paper and Pulp
- Process Control
- Seawater Desalination
- Environmental
- Potable Water
- Hydroponics
- Aquaculture
- Food and Beverage Processing
- Plating
- Swimming Pools & Spas
- Printing
- Brewing
- Distillation
- Bleach Manufacturing
- Coffee Industry
- Reduction of Chromate Waste

D. Features

- Flexibility to Meet any Application
- Mobile Device Style GUI and OS
- Large, Sharp, Color Touch Screen (3.5" QVGA LCD)
- Customizable Screen Layout
- Quick, Easy Installation
- Simultaneous Monitoring of Multiple Sensors
Including up to 7 Inputs:
 - 2 – Conductivity/Resistivity/TDS/Salinity
 - 1 – Pre-amplified pH/ORP
 - 1 – BNC pH/ORP/mV
 - 1 – 4-20 mA Input
 - 1 – Flow Rate and Volume Totalizer, Pulse Counter/Frequency Counter
 - 1 – Additional RTD Temperature Input
- % Rejection
- ¼ DIN Size Chassis
- Password Security Features
- Up to 3 Alarm/Control Relays, Configurable
- 0-10V Recorder Output, Fully Scalable
- 4-20/0-20 mA Isolated Output, Fully Scalable
- Up to 2 Remote Alarm Outputs
- Flow Switch Input
- Digital Calibration (no need to remove the front panel or adjust potentiometers)
- 3 Temperature Compensation Standards for Greatest Accuracy in Diverse Applications (KCl, NaCl, and 442 Natural Water™)
- User Adjustable Temperature Compensation (0 - 10%/°C), can be Disabled for Non-compensated Readings

II. SPECIFICATIONS

The 900 Series Multi-Parameter Monitor/Controller provides simultaneous measurement and control of multiple input and output channels. The specifications of the various features are listed below:

Power Supply

Low voltage, 12-24 VDC, 1A/24 VAC, 1A input

Optional 100-240 VAC input power adaptor, available from Myron L® Company



WARNING

To maintain the 900 Series Multi-Parameter Monitor/Controller IEC 61010-1 safety rating, only use external power supplies / adapters that are also IEC/UL 61010-1 or IEC/UL 60950-1 rated to the full operating temperature range of the instrument.

Fuses

Built-in fusible link (no user-replaceable fuses): 2 Amp 250 VAC

Display / User interface

Display: 3.5" Color LCD, high brightness, TFT
Resistive Touch Screen

Brightness: Adjustable from 0-100%

Status LED: Tri-color

Conductivity/Resistivity/TDS/Salinity Measurements

[Terminal Blocks: COND/RES1 and COND/RES2]

a. Conductivity

Range: 0 μ S – 200 mS

Resolution: 0.01 (<100 μ S)

0.1 (<1000 μ S)

1 (<10,000 μ S)

0.01 (<100 mS)

0.1 (\leq 200 mS)

Accuracy: \pm 1% of reading (factory calibration)

Units: μ S/mS (automatic)

Temperature Compensation:

Automatic compensation on KCl, 442™ and NaCl solutions from 0-71°C (32-160°F)

User adjustable temperature compensation: 0-10%/°C

Adjustable Conductivity/TDS Ratio Factor: 0.20 – 7.99

Cell Constant: User adjustable

Cable Length Compensation: User adjustable

b. Total Dissolved Solids (TDS)

Range: 0 ppm – 200 ppt

Resolution: 0.01 (<100 ppm)

0.1 (<1000 ppm)

1 (<10,000 ppm)

0.01 (<100 ppt)

0.1 (\leq 200 ppt)

Accuracy: \pm 1% of reading (factory calibration)

Units: ppm/ppt (automatic)

Temperature Compensation:

Automatic compensation on KCl, 442™ and NaCl solutions from 0-71°C (32-160°F)

User adjustable temperature compensation: 0-10%/°C

Adjustable Conductivity/TDS Ratio Factor: 0.20 – 7.99

Cell Constant: User adjustable

Cable Length Compensation: User adjustable

c. Resistivity

Range: 10 k Ω – 40 M Ω
 Resolution: 0.01 (<100 k Ω)
 0.1 (<1000 k Ω)
 0.01 (<10 M Ω)
 0.1 (\leq 40 M Ω)

Accuracy: \pm 1% of reading (factory calibration)

Units: k Ω /M Ω (automatic)

Temperature Compensation:

Automatic compensation on KCl, 442™ and NaCl solutions from 0-71°C/32-160°F

User adjustable temperature compensation: 0-10%/°C

Cell Constant: User adjustable

Cable Length Compensation: User adjustable

d. Salinity

Range: 0 – 200 ppt
 Resolution: 0.001 (<10 ppt)
 0.01 (<100 ppt)
 0.1 (\leq 200 ppt)

Accuracy: \pm 1% of reading (factory calibration)

Units: ppt

Temperature Compensation:

Automatic compensation on KCl, 442™ and NaCl solutions from 0-71°C (32-160°F)

User adjustable temperature compensation: 0-10%/°C

Cell Constant: User adjustable

Cable Length Compensation: User adjustable

pH/ORP

[Terminal Block: pH / ORP]

a. pH Measurements

Range: 0 – 14 pH
 Resolution: 0.01 pH
 Accuracy: \pm 0.01 pH (post solution calibration)
 Temperature Compensation:

Automatic compensation per Nernst equation, referenced to 3.5 M KCl Ag/AgCl reference electrode

pH temperature compensation may be turned off by selecting pH (TC Off)

Cable Length Compensation: User adjustable

b. ORP Measurements

Range: \pm 2000 mV
 Resolution: 1 mV
 Accuracy: \pm 2 mV (post solution calibration)
 Units: mV
 Temperature Compensation: N/A

RTD Input, Temperature Measurements

[Terminal Block: RTD]

Range: 0-250°C
 Resolution: 0.1°C/°F
 Accuracy: \pm 0.1°C
 Units: °C/°F (User selectable)
 Input Type: RTD, 1000 Ω
 Cable Length Compensation: User adjustable

mV Input, DC Measurements**[BNC Connector: mV IN]**

May be configured to display in ORP/mV or pH (w/TC) or pH (TC Off).

NOTE: The shorting BNC connector cap (included) must be installed when there is no sensor connected to the mV input.

a. pH Measurements

Range: 0-14 pH

Resolution: 0.01 pH

Accuracy: ± 0.01 pH

Units: pH

Temperature Compensation (requires temperature sensor installed in the RTD input):

Automatic compensation per Nernst equation, referenced to 3.5 M KCl Ag/AgCl reference electrode

pH temperature compensation may be turned off by selecting pH (TC Off)

b. ORP/mV Measurements

Range of Measurement: +/- 2000 mV

Resolution: 1 mV

Accuracy: ± 2 mV

Units: mV

Temperature Compensation: N/A

0/4-20 mA Input, Loop Powered, Non-isolated, DC Measurements**[Terminal Block: 4-20 mA IN]**

Range of Measurement: 0/4-20 mA

Resolution:

Current Mode: 0.01 mA

Measurement Mode: 0.01 (<100)

0.1 (<1000)

1 (≥ 1000)

Accuracy: $\pm 1\%$ of reading

Units:

Current Mode: mA

Measurement Mode: User selectable (gpm, gph, lps, lpm, lph, Gal, Ltr, %, PSI, NTU, μ S, mS, ppm, ppt, mV, V, $^{\circ}$ C, $^{\circ}$ F, Ω , k Ω , M Ω , mA, Hz, kHz)

Temperature Compensation: Not available

Input Impedance: < 600 Ω

Galvanic Isolation: Not available

Flow / Pulse Input Measurements**[Terminal Block: FLO/PULSE]**

Range of Measurement: 0.5 to 50,000 pulses per second

Resolution: 0.001 (<10)

0.01 (<100)

0.1 (<1000)

1 (≥ 1000)

Accuracy: ± 1 Hz or $\pm 1\%$ of reading

Units: Hz, KHz (automatic)

Temperature Compensation: N/A

Input Type:

Schmitt trigger, TTL input

Open collector

Dry Contact, debounced

Flow Switch/Kill Switch Input

[Terminal Block: FLOW SW]

Input Type:

- TTL Input
- Open Collector
- Dry Contact

NOTE: The jumper (included) must be installed in the terminal block connector if there is no flow/level switch installed.

Relay Outputs

 WARNING	Use caution when selecting cabling for Relay Outputs. Use at least 14 gauge conductors.
---	---

[Terminal Block: RELAY #1, RELAY #2 and RELAY #3]

Contact Type: Type 1C, normally open/normally closed/common

Contact Rating

- Max Current: 5 Amp @ 30 VDC
- 8 Amp @ 250 VAC 50/60 Hz
- Max Voltage: 30VDC/250VAC max at 50/60 Hz
- Dielectric Strength: 750VAC
- Operate Time: 10 msec

Control Capability

1 to 3 Relays (1 relay on model 900M-1C, 3 relays on model 900M-3C)

Set point: 0-100% of measurement range

Hysteresis: 0.3-5% of reading

2-100 mV ORP

Triggering conditions:

Rising above a set point

Falling below a set point

Within Window of a measurement

Out of Window of a measurement

Warning: Approaching +/- 10% of set point

Visual Indicators

Screen background color and front bezel LED color status indicators:

Blue indicates the measurement is within normal operating range

Yellow indicates the measurement value is within warning range

Red indicates the measurement value has reached or gone beyond the set point

Alarm Outputs

[Terminal Block: RA #1 AND RA #2]

Compatible Alarm Type

Piezo Electric Alarm Model PAO (See “ACCESSORIES, Piezo Electric Alarm”, page 100)

Remote Alarm Model RA (See “ACCESSORIES, Remote Alarm – RA™”, page 98)

User Supplied Alarm

Alarm Output Electrical Rating

Max Current: 20 mA DC

Max Voltage: 20V DC

Control Capability

1 to 2 Alarms (1 alarm on model 900M-1C, 2 alarms on model 900M-3C)

Set Point: 0-100% of measurement range

Hysteresis: 0.3-5% of reading

2-100 mV ORP

Triggering Conditions:

Rising above a set point

Falling below a set point

Within Window of a measurement

Out of Window of a measurement

Warning: Approaching +/- 10% of set point

Visual Indicators:

Screen background color and front bezel LED color status indicators:

Blue indicates the measurement is within normal operating range

Yellow indicates the measurement value is within warning range

Red indicates the measurement value has reached or gone beyond the set point

0-10 VDC Output, Measurement output as voltage

[Terminal Block: REC O/P]

Output: Output voltage: 0-10V

Output current capability: 20 mA max

Accuracy: +/- 1% of reading

0/4-20mA Output, Measurement output as current with isolation

[Terminal Block: 4-20mA OUT]

Output: Isolated Output current capability: 0/4-20 mA max

Compatible with loop powered or self-powered current receiving device

Loop Power supply input range: 20-36 VDC

Accuracy: +/- 1% of reading

Mechanical Specifications:

Operating Temperature: 0 – 60 °C / 32 – 140 °F

Maximum Operating Altitude: 2000 meters (6560 feet)

Maximum Humidity: <90% RH, Non Condensing

Storage Temperature: 0 – 75 °C / 32 – 167 °F

Weight: 900M-1C: 0.85 lb / 0.39 kg

900M-3C: 1.0 lb / 0.45 kg

Housing Specifications:

- Industrial standard ¼ DIN chassis/panel cutout
- Easy access terminal connections to sensors and control outputs
- Enclosure Material: PC/ABS
- Enclosure Rating: IP65/NEMA 4X (front/face only), IP20 (housing)
- Dimensions (housing, without connectors):

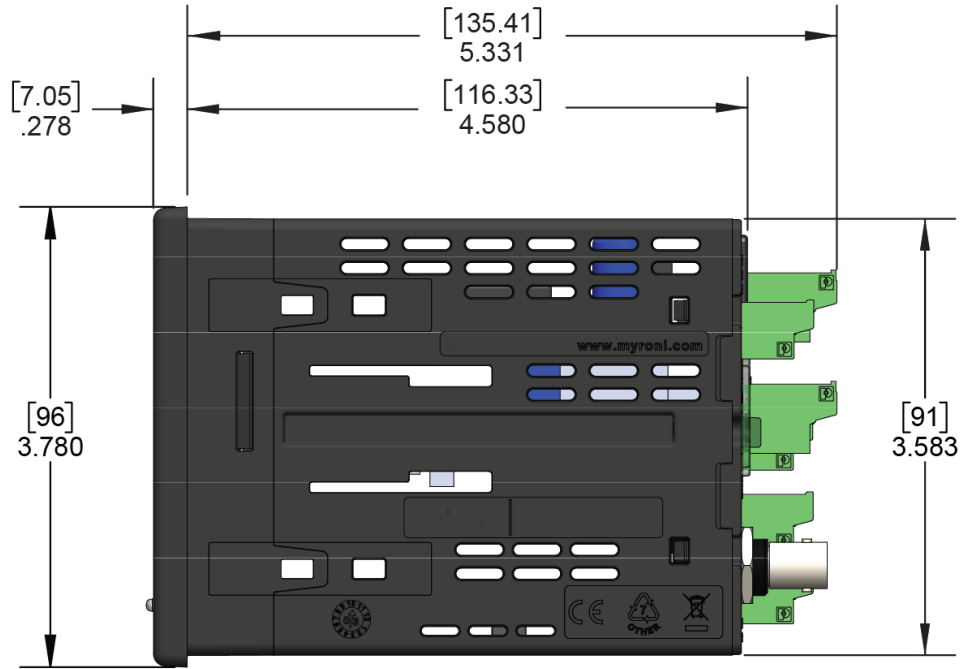

NOTE: The above dimensions do not reflect panel cutout dimensions or panel depth necessary for connectors or cabling with service loop. See page 23 for panel cutout dimensions.

III. ORDERING INFORMATION

A. 900 Series Models

Order Part #	Description
900M-1C	Monitor/Controller with 1 Relay, 1 Alarm
900M-3C	Monitor/Controller with 3 Relays, 2 Alarms, and 4-20 mA Output

1. 900 Series Model Features

		900M-1C	900M-3C
INPUTS			
COND / RES 1	Conductivity, Resistivity, TDS, or Salinity Sensor Input	✓	✓
COND / RES 2	Conductivity, Resistivity, TDS, or Salinity Sensor Input	✓	✓
pH / ORP	Myron L® Company Pre-amplified pH or ORP Sensor Input	✓	✓
mV IN	BNC Style mV Model Sensors (pH/ORP/mV)	✓	✓
FLOW SW	Flow Switch Input	✓	✓
4-20 mA IN	4-20 mA Signal Input	✓	✓
FLOW / PULSE	Flow Rate and Volume Totalizer, Pulse/Frequency Counter	✓	✓
RTD	Temperature Sensor Input (1000 Ω RTD)	✓	✓
24 VAC / 12-24 VDC	Power Supply Input	✓	✓
OUTPUTS			
RELAY #1	Normally Open or Normally Closed Relay Output	✓	✓
RELAY #2	Normally Open or Normally Closed Relay Output		✓
RELAY #3	Normally Open or Normally Closed Relay Output		✓
RA #1	Remote Alarm Output	✓	✓
RA #2	Remote Alarm Output		✓
4-20 mA OUT	4-20 mA Signal Output		✓
REC O/P	0-10 VDC Recorder Output	✓	✓

NOTE: Sensors sold separately. Please specify sensor(s) required when ordering.

B. Sensors

For detailed descriptions of these and other available sensors see the sensor data sheets or contact your local distributor or the Myron L[®] Company.

1. Conductivity/Resistivity/TDS/Salinity Sensors

All Myron L[®] Company 900 Series Conductivity/Resistivity/TDS/Salinity Sensors contain a built-in precision 1000Ω RTD temperature sensor, mount into a standard ¾" NPT tee fitting, and come with a 10 ft./3 meter shielded cable attached.

a) Conductivity/TDS/Salinity Sensors

The 900 Series Multi-Parameter Monitor/Controller's Conductivity, TDS, and Salinity use the CS951 or CS952 Sensors depending on the range and application.

Order Part #	Description
CS951	Conductivity/TDS, ¾" NPT, 0-20,000 μS/ppm, 0.85 cell constant, 10 ft./3 meter cable.
CS951-25	Conductivity/TDS, ¾" NPT, 0-20,000 μS/ppm, 0.85 cell constant, 25 ft./7.6 meter cable.
CS951-100	Conductivity/TDS, ¾" NPT, 0-20,000 μS/ppm, 0.85 cell constant, 100 ft./30.5 meter cable.
CS951LS	Conductivity/TDS, long style, ¾" NPT, 0-20,000 μS/ppm, 0.85 cell constant, 10 ft./3 meter cable.
CS951LS-25	Conductivity/TDS, long style, ¾" NPT, 0-20,000 μS/ppm, 0.85 cell constant, 25 ft./7.6 meter cable.
CS951LS-100	Conductivity/TDS, long style, ¾" NPT, 0-20,000 μS/ppm, 0.85 cell constant, 100 ft./30.5 meter cable.
CS952	Conductivity/TDS/Salinity, ¾" NPT, >20,000 μS/ppm, 10.0 cell constant, 10 ft./3 meter cable.
CS952-25	Conductivity/TDS/Salinity, ¾" NPT, >20,000 μS/ppm, 10.0 cell constant, 25 ft./7.6 meter cable.
CS952-100	Conductivity/TDS/Salinity, ¾" NPT, >20,000 μS/ppm, 10.0 cell constant, 100 ft./30.5 meter cable.

b) Resistivity Sensors

The 900 Series Multi-Parameter Monitor/Controller's Resistivity uses the CS910 Sensors for use with ultrapure water applications.

Order Part #	Description
CS910	Resistivity, ¾" NPT, 10 kΩ-20 MΩ, 0.05 cell constant, 10 ft./3 meter cable.
CS910-25	Resistivity, ¾" NPT, 10 kΩ-20 MΩ, 0.05 cell constant, 25 ft./7.6 meter cable.
CS910-100	Resistivity, ¾" NPT, 10 kΩ-20 MΩ, 0.05 cell constant, 100 ft./30.5 meter cable.
CS910LS	Resistivity, long style, ¾" NPT, 10 kΩ-20 MΩ, 0.05 cell constant, 10 ft./3 meter cable.
CS910LS-25	Resistivity, long style, ¾" NPT, 10 kΩ-20 MΩ, 0.05 cell constant, 25 ft./7.6 meter cable.
CS910LS-100	Resistivity, long style, ¾" NPT, 10 kΩ-20 MΩ, 0.05 cell constant, 100 ft./30.5 meter cable.

c) Conductivity/Resistivity/TDS/Salinity Sensor Cable Extensions

Order Part #	Description
CBL-12395-1	Sensor Cable Extension Kit (cable and connectors), Conductivity/Resistivity/TDS/Salinity, 25 ft./7.6 meter
CBL-12395-2	Sensor Cable Extension Kit (cable and connectors), Conductivity/Resistivity/TDS/Salinity, 100 ft./30.5 meter
MCRD-(length)	Conductivity/Resistivity/TDS/Salinity Sensor Cable (cable only), must specify length (Example: MCRD-300 is 300 ft./91.4 meter)
TBD	Sensor Cable Extension Connector (connectors only), Conductivity/Resistivity/TDS/Salinity

2. Pre-amplified pH/ORP Sensors (for use with the 900 Series pH/ORP Input)

All Myron L® Company 900 Series Pre-amplified ½” and ¾” NPT pH and ORP sensors have Ryton® (PPS) sensor bodies and come with 10 ft./3 meter shielded cables attached. These sensors contain built-in precision 1000Ω RTD temperature sensors.

a) Pre-Amplified pH Sensors

½” pH Sensors

Order Part#	Description
P92	pH, ½” NPT, bulb tip, Pellon® junction, 10 ft./3 meter cable

¾” pH Sensors

Order Part#	Description
P94	pH, ¾” NPT, bulb tip, Pellon® junction, 10 ft./3 meter cable
P94PE	pH, ¾” NPT, hemi tip, polyethylene (PE) junction, 10 ft./3 meter cable
P94FPE	pH, ¾” NPT, flat tip, polyethylene (PE) junction, 10 ft./3 meter cable

b) Pre-Amplified ORP Sensors

½” ORP Sensors

Order Part#	Description
O92	ORP, ½” NPT, extended tip, Pellon® junction, 10 ft./3 meter cable

¾” ORP Sensors

Order Part#	Description
O94	ORP, ¾” NPT, extended tip, Pellon® junction, 10 ft./3 meter cable
O94PE	ORP, ¾” NPT, extended tip, polyethylene (PE) junction, 10 ft./3 meter cable
O94FPE	ORP, ¾” NPT, flat tip, polyethylene (PE) junction, 10 ft./3 meter cable

c) pH/ORP Sensor Cable Extensions (for use with pre-amplified sensors)

Order Part #	Description
CBL-12396-1	Sensor Cable Extension Kit (cable and connectors), pH/ORP, 25 ft./7.6 meters
CBL-12396-2	Sensor Cable Extension Kit (cable and connectors), pH/ORP, 100 ft./30.5 meters
PHCRD9	pH Sensor Cable (cable only), must specify length (Example: PHCRD9-300 is 300 ft./91.4 meter)
TBD	Sensor Cable Extension Connectors (connectors only), pH/ORP

3. BNC Style pH/ORP Sensors (for use with the 900 Series mV Input)

All 900 Series BNC Style pH/ORP sensors have Ryton® (PPS) sensor bodies with 10 ft./3 meter shielded cables attached.

NOTE: BNC Style pH/ORP sensors are not pre-amplified and do not include temperature sensors.

NOTE: The shorting BNC connector cap (included with the 900) must be installed when there is no sensor connected to the mV Input.

a) BNC Style pH Sensors

½” pH Sensors

Order Part#	Description
P92B	pH, ½” NPT, bulb tip, BNC, Pellon® junction, 10 ft./3 meter cable, plain body

¾” pH Sensors

Order Part#	Description
P94BPE	pH, ¾” NPT, hemi tip, polyethylene (PE) junction, 10 ft./3 meter cable
P94FBPE	pH, ¾” NPT, flat tip, polyethylene (PE) junction, 10 ft./3 meter cable

b) BNC Style ORP Sensors

½” ORP Sensors

Order Part#	Description
O92B	ORP, ½” NPT, bulb tip, BNC, Pellon® junction, 10 ft./3 meter cable, plain body

¾” ORP Sensors

Order Part#	Description
O94BPE	ORP, ¾” NPT, extended tip, polyethylene (PE) junction, 10 ft./3 meter cable
O94FBPE	ORP, ¾” NPT, flat tip, polyethylene (PE) junction, 10 ft./3 meter cable

4. Temperature Sensors

Order Part#	Description
ITS1	Independent Temperature Sensor, ¼” NPT, 0 -120°C / 32-248°F, 1000Ω RTD, 3-wire, 25 ft./7.6 meter cable
ITS1-HT	Independent Temperature Sensor, ¼” NPT, High Temperature, 0-185°C / 32-365°F, 1000Ω RTD, 3-wire, 25 ft./7.6 meter cable

5. Flow Meter

Order Part#	Description
SPX-075	Flow Meter, ¾” Female NPT, (0.2-20 gpm), Polypropylene, Single Jet, Low Flow

For additional/special order sensors contact your local distributor or the Myron L® Company.

IV. INSTALLATION

A. Unpacking and Inspection of Equipment

1. Inspect the shipping container. If it is damaged contact the shipper immediately for instructions. (Do not discard the box.)
2. If there is no apparent damage, unpack the container. Be sure all items shown below are present. If items are missing, notify the supplier immediately.

Contents of the 900 Series Multi-Parameter Monitor/Controllers:











Model 900M-1C

- 900 Series Monitor/Controller Model 900M-1C
- Panel Mounting Brackets – 2 ea.
- Screws – 2 ea.
- Ferrite Bead
- Quick Start Guide
- Terminal Block Mating Connectors, Installed:
 - Power Input
 - Relay (1 ea.)
 - 4-20 mA Input
 - Flow Switch Input (with jumper)
 - Flow / Pulse Input
 - RTD Input
 - 0-10 VDC Recorder Output
 - Shorting BNC Protective Cover
- 2.0 mm Standard Screwdriver (for terminal blocks)
- Remote Alarm Harness (1 ea.) with Wire Nuts (2 ea.)
- Certificate of Compliance

Model 900M-3C

- 900 Series Monitor/Controller Model 900M-3C
 - Panel Mounting Brackets – 2 ea.
 - Screws – 2 ea.
 - Ferrite Bead
 - Quick Start Guide
 - Terminal Block Mating Connectors, Installed:
 - Power Input
 - Relays (3 ea.)
 - 4-20 mA Input
 - Flow Switch Input (with jumper)
 - Flow / Pulse Input
 - RTD Input
 - 0-10 VDC Recorder Output
 - Shorting BNC Protective Cover
 - 4-20 mA Output
 - 2.0 mm Standard Screwdriver (for terminal blocks)
 - Remote Alarm Harness (2 ea.) with Wire Nuts (4 ea.)
 - Certificate of Compliance
3. Record identification information on page 2 of this manual.

B. Installing the 900 Series Multi-Parameter Monitor/Controller

 WARNING	<p>Under no circumstances may the device be installed or removed while under voltage! This poses the risk of electrocution.</p> <p>Switch-off the entire system beforehand.</p> <p>This work must be performed only by qualified personnel!</p> <p>The device must never be installed in potentially-explosive areas! There is the risk of an explosion.</p>
 WARNING	<p>For protection against electrical shock hazards, the equipment must be directly connected to an approved power supply with the power supply cord set which is provided by the manufacturer.</p> <p>Do not use an ungrounded receptacle. Any break in the electrical ground path could be hazardous.</p> <p>If the power cord becomes cracked, frayed, broken, or otherwise damaged, it must be replaced.</p> <p>Do not replace with a lower rated cord set.</p>
 WARNING	<p>To maintain the 900 Series Multi-Parameter Monitor/Controller IEC 61010-1 safety rating, only use external power supplies / adapters that are also IEC/UL 61010-1 or IEC/UL 60950-1 rated to the full operating temperature range of the instrument.</p>
 WARNING	<p>A switch or circuit-breaker must be included in the installation;</p> <p>It must be easily reached;</p> <p>It must be marked as the disconnecting device for the equipment power supply.</p>
 WARNING	<p>The sides and back of the 900 Series Monitor/Controller must be protected from:</p> <ul style="list-style-type: none"> • Stream or spray of water. • High-humidity, condensing atmosphere. • High dust environments. <p>If there is a likelihood that the sides or back of the instrument could be exposed to one of these conditions, the 900 Series Monitor/Controller must be installed in an appropriate type of humidity controlled, water-proof and / or dust-proof enclosure.</p>
 WARNING	<p>To maintain the IP65 rating of the front panel and IEC61010-1 Safety certification of the entire instrument:</p> <ul style="list-style-type: none"> • The instrument must be panel mounted. • Mounted in such a way as to protect the front panel from impacts ≥ 1 joule.
 CAUTION	<p>ALWAYS install and operate the 900 Monitor/Controller in an environment that conforms to its operating specifications. Exposing the 900 Monitor/Controller to environmental extremes may affect the instrument's accuracy and reliability.</p>
 CAUTION	<p>Make sure the environment is free of small metal objects that could gain ingress into the 900 Series Monitor/Controller and potentially cause a short circuit.</p>
 CAUTION	<p>BEFORE applying power to the 900 Series Monitor/Controller verify that all input and output connections are properly wired and attached to the correct connector on the 900 Series Monitor/Controller's back panel.</p>
 CAUTION	<p>Do not position AC/DC adapter or power supply unit in such a way as to block easy access to any mains disconnect device (appliance coupler or plug) or in any way that makes it difficult to disconnect from the facilities MAINS CIRCUITS.</p>

1. Select a Mounting Site

When selecting a location for the 900, avoid locations subject to direct sunlight, or temperatures or humidity outside the specified ranges. Be sure to leave sufficient space in the back of the panel for connectors, cabling with a service loop, and ventilation. The 900 should be mounted on a vibration-free structure, in a location where liquids will not be splashed on it. Any water splashed on the LCD should be immediately wiped dry using a soft absorbent cloth. Any water splashed behind the front bezel WILL DAMAGE the instrument.

For optimal viewing and programmability, the display should be at eye level. The 900 should be mounted prior to connecting cabling.

NOTE: It is suggested that the user mount watertight restraint fixtures with strain relief as well as a service loop on all cabling. All cabling should be routed using best practices to protect from damage and/or signal interference. Consider grounded steel conduit to protect against interferences such as RF. Signal cables should be routed separate from line power cables or any other source of interference.

NOTE: An optional 900 Series mounting bracket adapter is available to mount the 900 Series in a panel previously cut out for a 700 Series Monitor/Controller, order part number 9MBAPC (see Mounting Brackets, page 102).

 WARNING	Sharp tools can scratch or damage the LCD.
---	--

2. Panel Mounting

 CAUTION	Ensure that the control panel provides adequate support for the device. The weight values listed in the technical data as well as cabling must be taken into account to ensure adequate mechanical stability for control panel installation.
--	--

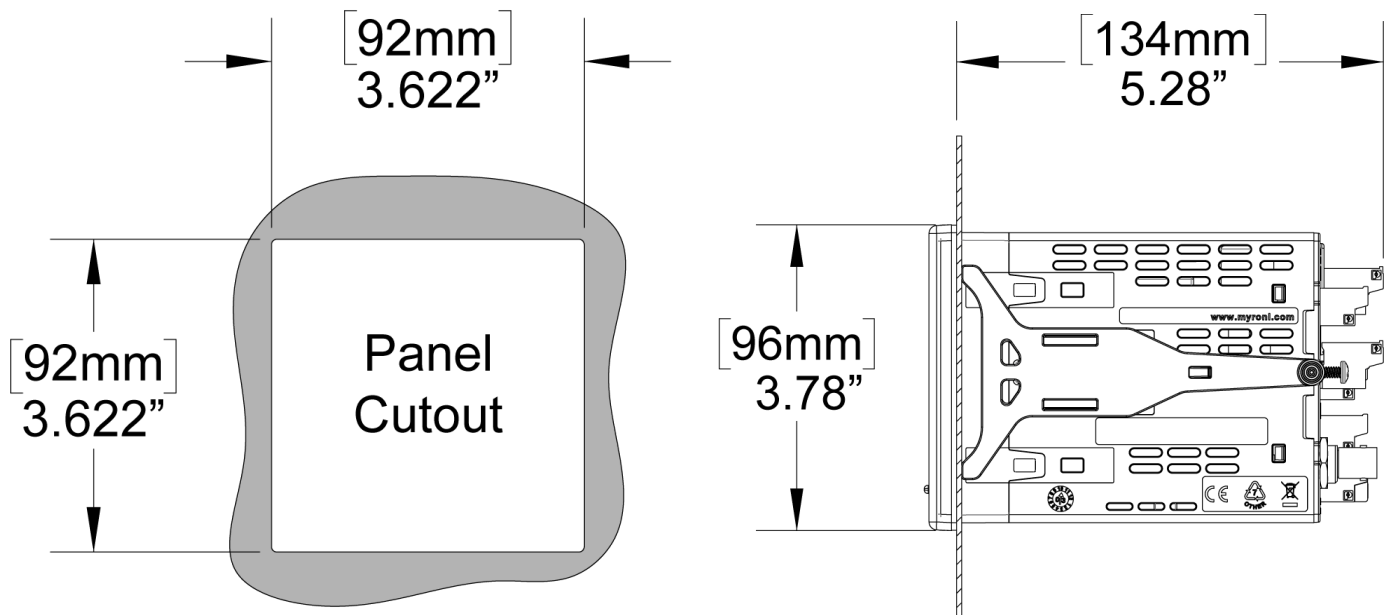

Images Not to Scale

NOTE: If several devices are to be mounted on a panel next to each other, the panel cutouts must be positioned at least 0.56"/14mm horizontally and vertically away from each other.

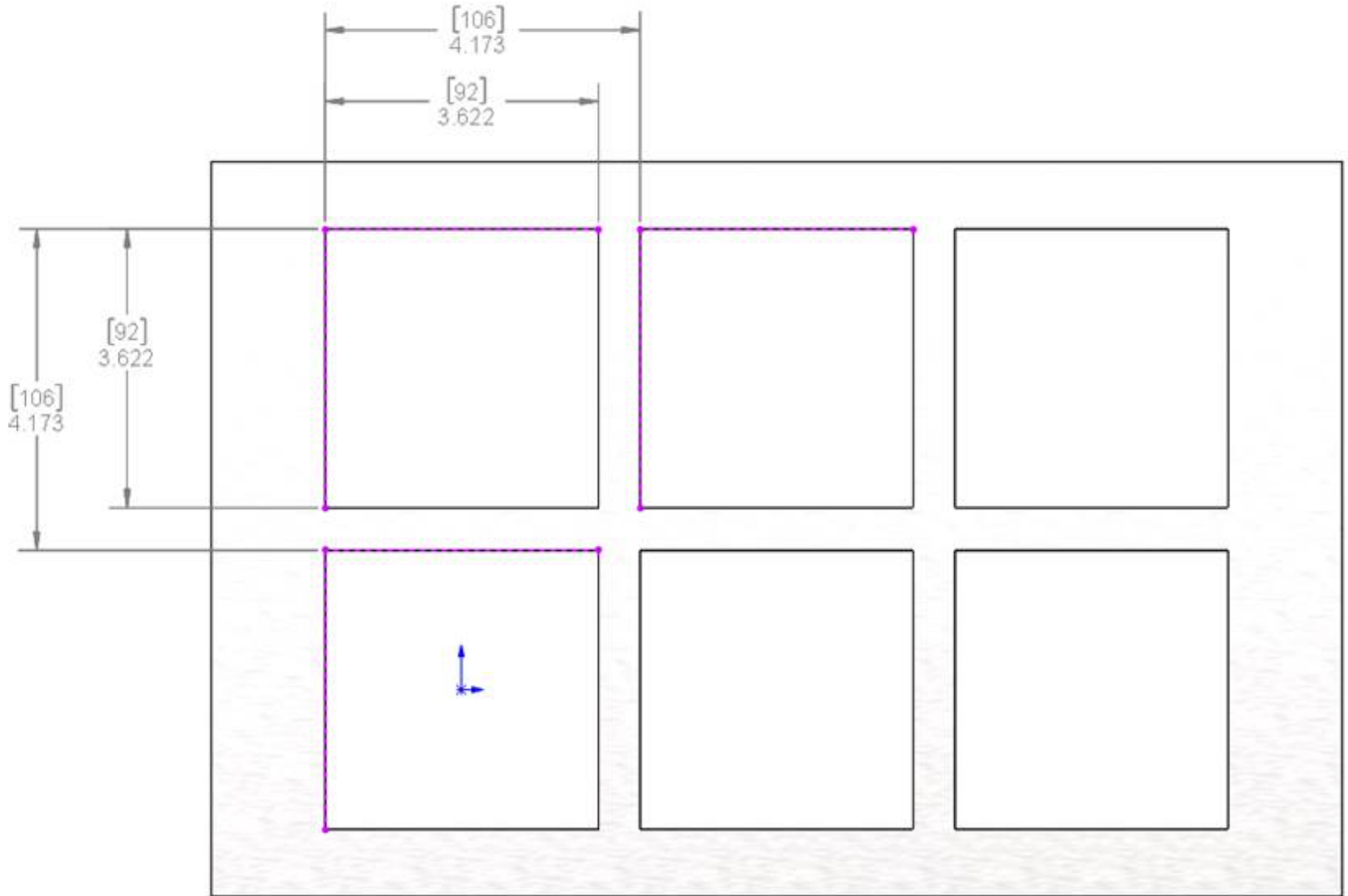
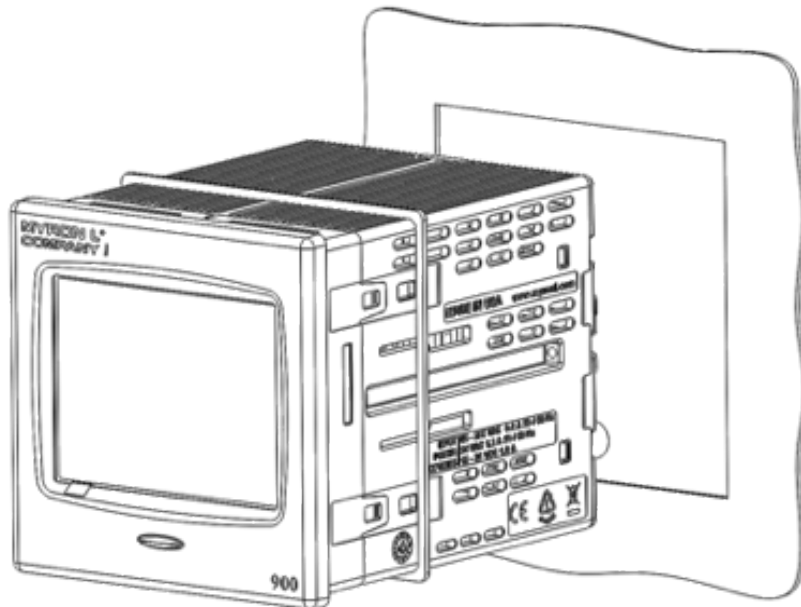
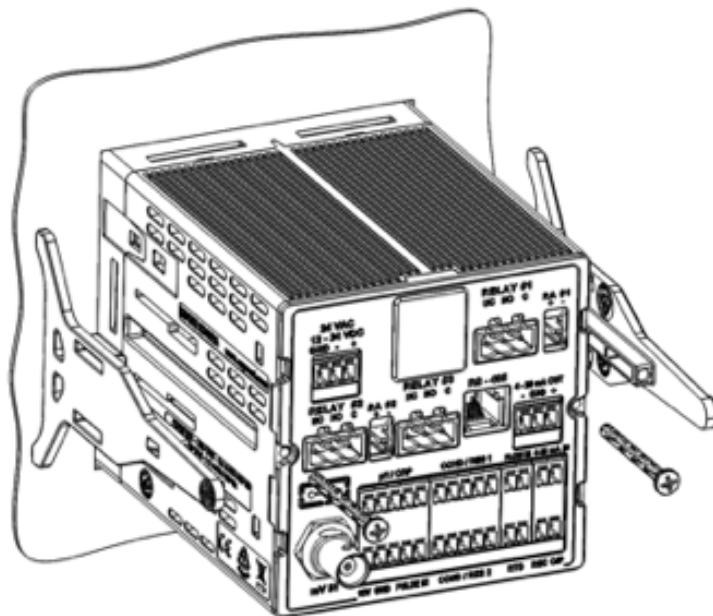

Image Not to Scale

1. After selecting the mounting location, mark the appropriate panel cutout and complete the necessary cuts.
2. Deburr the cutout edges to prevent damage and allow a watertight seal.
3. Place the panel gasket on the 900 and position it against the back of the bezel.
4. Gently insert the 900 through the panel cutout; ensuring the panel gasket remains flat and properly aligned between the bezel and the panel.



5. While holding the front of the instrument firmly to the panel, insert panel mounting brackets into the sides of the 900, and slide forward to the panel.
6. Insert the screws and tighten the panel mounting brackets to secure the 900. The gasket should be evenly compressed to 50% of its original thickness (this will leave approximately 0.05 in./1.27 mm gap between the bezel and panel). Do NOT over-tighten.
7. Verify the panel gasket has remained properly installed between the bezel and panel.



Images Not to Scale

C. Installing Sensors

 WARNING	<p>Sensors supplied by Myron L[®] Company are specifically designed to be compatible with the 900 Series Monitor/Controller. They are supplied with properly wired mating connectors and have been tested to ensure the proper function of the sensor and of the 900 Series Monitor/Controller.</p> <p>Hazardous conditions could be created by:</p> <ul style="list-style-type: none"> • Incorrectly wiring the connector. • Using a 3rd party sensor whose termination may not match the requirements of the 900 Series Monitor/Controller.
---	---

1. Installing Conductivity/Resistivity/TDS/Salinity Sensors

The sensor's mounting orientation must provide a continuous and adequate circulation flow to prevent the trapping of air bubbles within the sensor's electrode area (CS951 shown below). Failure to do so will result in conditions that will prevent the sensor from functioning properly.

a) Insertion Mode (in-line installation)

- Use approved sealant, i.e. Teflon™ tape as required.
- Verify that the sensor's fittings are properly assembled as shown.
- Insert the sensor fitting assembly into the "T" fitting with electrode aligned as shown below and tighten securely.

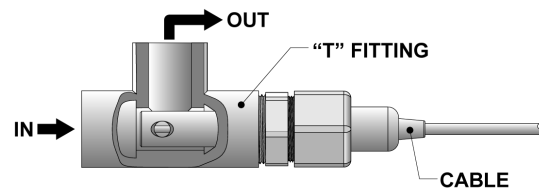
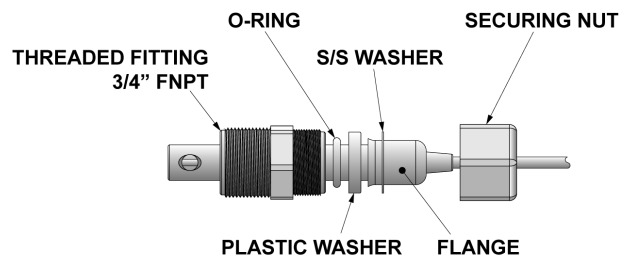

b) Immersion or Dip Sensor Assembly

- Use approved sealant, i.e. Teflon™ tape as required.
- Verify that the sensor's fittings are properly assembled as shown below.
- Insert and pull the sensor's cable through the extension tube and then tightly attach extension tube to the sensor assembly.

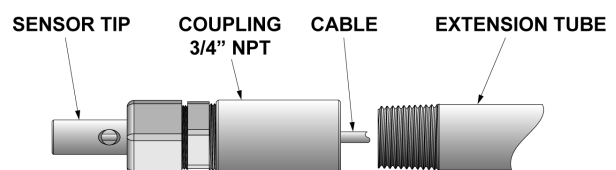
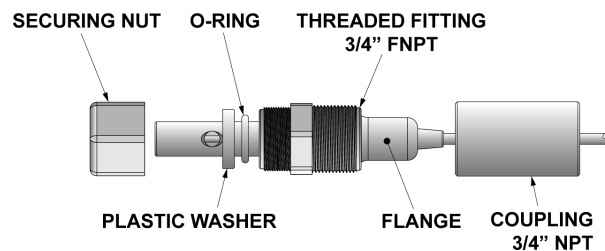

2. Installing pH/ORP Sensors

Most Myron L® Company pH/ORP Sensors can be mounted at any angle. There should be a continuous and adequate flow to prevent the trapping of air bubbles within the sensor's electrode which could prevent the sensor from functioning properly.

a) Insertion Mode (in-line installation)

Use one of the following as a guide. Substitute ORP sensor for pH where applicable.

- Use approved sealant, i.e. Teflon™ tape as required.
- Insert the sensor into the "T" fitting as shown in one of the figures below.
- Tighten securely.



Most Myron L® Company pH and/or ORP sensors may be installed in the base of a "T" fitting at any angle, including inverted.

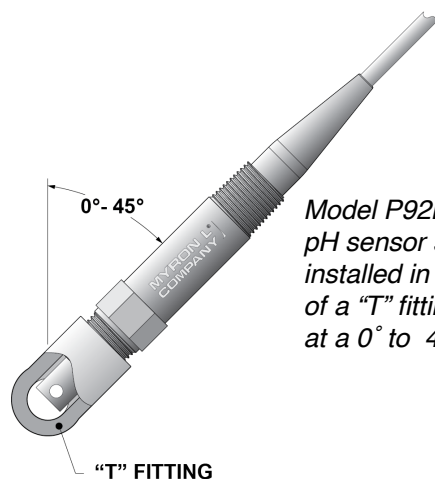

Model P92B, BNC style pH sensor should be installed in the base of a "T" fitting and at a 0° to 45° angle.

b) Immersion or Dip Sensor Assembly

- Use approved sealant, i.e. Teflon™ tape as required.
- Insert and pull the sensor's cable through the extension tube as shown in figure below.
- Tightly attach extension tube to sensor as shown in figure below.

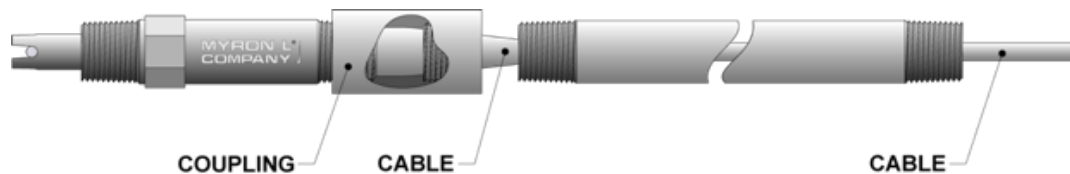

The Pre-Amplified sensor's cable may be extended as necessary, see pH/ORP Sensor Cable Extensions Section on page 19.

D. Electrical Installation









The electrical installation procedures provided in this manual are common to all 900 Series Multi-Parameter Monitor/Controllers. The 900 Series are powered by 24 VAC / 12-24 VDC. Before starting, ensure the input power supply is correct. Failure to do so is beyond the responsibility of the Myron L[®] Company. Refer to the “Back Panel Connector Locations” illustration on page 30 for the location of input/output terminal blocks.

NOTE: It is suggested that the user create a service loop on all cabling during installation.

NOTE: A device to disconnect the 900 Series Monitor/Controller from the power supply must be installed. This switch or circuit breaker should be clearly labeled as the disconnection device for the Model 900.

NOTE: When there is NO sensor connected to the mV Input, the Shorting BNC Protective Cover (included) must be installed on the BNC connector on the back of the 900.

NOTE: When there is NO flow or level switch installed in the Flow Switch Input, the jumper (included) must be installed in the Flow Switch terminal block connector on the back of the 900.

 WARNING	<p>To maintain the 900 Series Multi-Parameter Monitor/Controller IEC 61010-1 safety rating, only use external power supplies / adapters that are also IEC/UL 61010-1 or IEC/UL 60950-1 rated to the full operating temperature range of the instrument.</p> <ul style="list-style-type: none"> • ALWAYS make sure that the ferrite bead supplied with the 900 Series is installed around the power input cabling.
 WARNING	<p>To avoid a possible hazardous condition:</p> <ul style="list-style-type: none"> • Make sure that the wiring used to connect any device to the 900 Series Monitor/Controller relay outputs is at least 14 AWG. • Power input by the connected device must not exceed 250 VAC / 8A or 30 VDC / 5A.
 WARNING	<p>If using a power supply other than one supplied by Myron L[®] Company, the cable of that power supply must meet the following minimum requirements:</p> <ul style="list-style-type: none"> • 24-gauge, copper wire. • Rated for 12-24 VDC or 24 VAC at 1 Amps. <p>Make sure that appropriate voltage and current ratings are met before applying the power to the 900 Monitor/Controller.</p>
 WARNING	<p>IF there are cracks or ANY damage to the front panel or touch screen of the instrument:</p> <ul style="list-style-type: none"> • DO NOT touch the instrument. • Immediately remove main power from the instrument’s power input and all relay contacts by interrupting them at the mains power panel switches or circuit breakers. • Replace the instrument.
 CAUTION	<p>The touchscreen must not be operated with sharp or pointed objects, as these could damage the protective film and the touchscreen.</p>
 CAUTION	<p>Prior to startup, ensure that the device has been installed and connected properly and in compliance with the installation instructions. Observe all safety instructions within this operation manual.</p>
 CAUTION	<p>If the equipment is used in a manner not specified by the manufacturer, the protection provided by the equipment may be impaired.</p>
 CAUTION	<p>Besides incorrect installation, incorrect settings and/or values can impair performance of the connected process or cause damage. Therefore, always use safety devices independent of the device and allow only qualified personnel to make or change settings.</p>

1. Wiring Inputs and Outputs to the Connectors

The terminal block mating connectors should be unplugged from the back of the 900 while attaching the cable wires. If routing the cable through a conduit or strain relief, you should do that before attaching to the terminal block connector.

The following diagrams are the basic wiring for each input/output with its corresponding terminal block (indicated by TB: XXX). Each wire should be stripped and tinned approximately ¼ inch. Insert each wire into its corresponding slot, then using a small screwdriver, tighten each wire securely by turning the screw in a clockwise direction.

NOTE: For more detailed information and alternate wiring options, see Detailed Operating Instructions for specific functions.

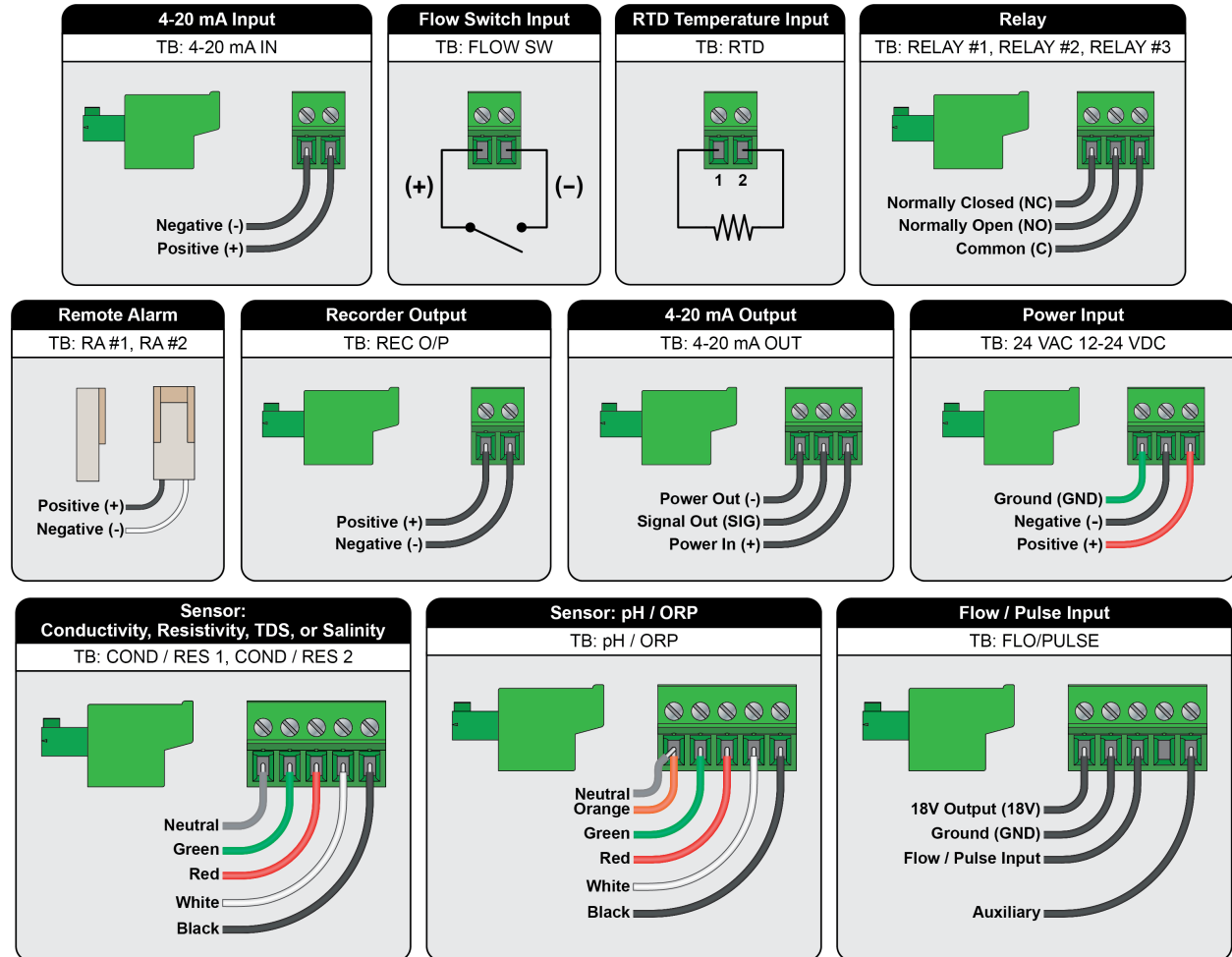

2. Install Ferrite Bead on Power Cable

If you are using part number PWRADAPT Power Adapter, the ferrite bead is already installed. If you are using an alternative power supply, the ferrite bead, included with the 900, should be installed on the power supply cable 4 inches from the terminal block connector.

To install the ferrite bead:

1. Wrap the power supply cable around the core.
2. Close the ferrite bead and snap together.

NOTE: If power supply cable diameter is too large and will not allow the ferrite bead to snap together, purchase a larger ferrite bead from your local electronics store.

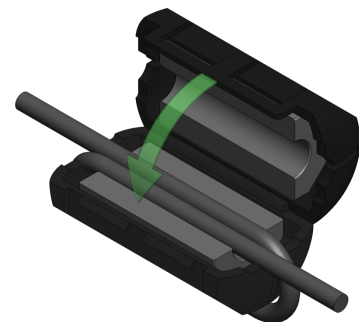

3. Connecting Inputs, Outputs, and Power to the 900

The 900 Series Multi-Parameter Monitor/Controllers utilize pluggable terminal blocks. Once the mating connectors are wired, with the power supply OFF, simply plug each connector into the corresponding terminal block (See Back Panel Connector Locations below). Once everything is installed and connected, simply turn the power supply ON, and begin programming. The first time the 900 is powered up it will go into the Initial Setup (see Section V).

4. Back Panel Connector Locations

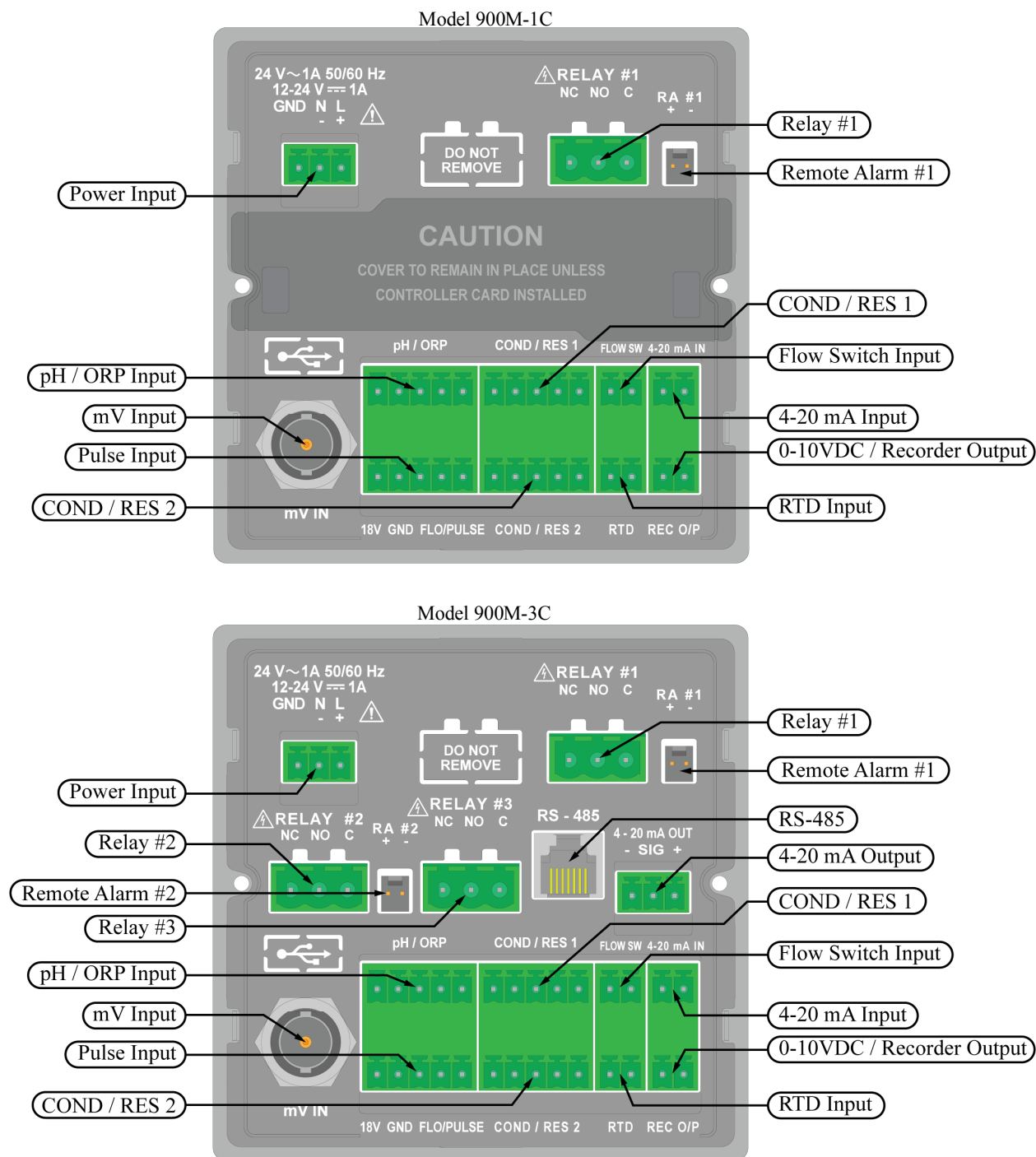

V. INITIAL SETUP

When you power-up the 900 for the first time the instrument will display the Myron L® Company Logo for a few seconds, then go to the “Initial Setup” screen. Here you will set the Date/Time, Location, Administrator Password, enable/disable Input Channels and select the Screen Layout.

The 900 is programmed through the resistive touchscreen using your fingertip or a stylus (a commercially available pointer with a rounded plastic or rubber tip). Do NOT use sharp objects, as these could damage the protective film and the touchscreen.

NOTE: For more detailed information including measurement types, sensor settings, and advanced settings, see DETAILED OPERATING SETTINGS (Section VII).

Initial Setup Screen

On the Initial Setup screen, the white text indicates an active field, and gray text indicates fields that have not yet been activated.

The Initial Setup is structured to walk you through each of the initial system settings, beginning with Date/Time. Once the Date/Time is set up, tap the **NEXT** button and the display will go to the “Set Up Location Info” screen, and so on.

 If you want to skip the Location or Password settings, simply tap the **NEXT** button.

NOTE: If the instrument has been previously set up, the Initial Setup will not be available (see DETAILED SYSTEM SETTINGS, page 52) to set up or adjust the Date/Time, Location, Passwords, Input Channels and/or Display settings.

Alternatively, you can perform a Factory Reset, to erase ALL settings (including any calibration adjustments) and start the Initial Setup from the beginning (see Factory Reset, page 67).

A. Date and Time

To set the date and time:

1. Tap the “Date/Time” field.
2. Tap the date field.
 - a. Tap the date format you prefer; MM/DD/YYYY, DD/MM/YYYY or YYYY/MM/DD.
 - b. Tap the **NEXT** button. The display will go to the “Adjust Date” screen.
 - c. Using the up and down arrows, set the correct date.
 - d. Tap the **ACCEPT** button. The display will return to the “Set Up Date and Time” screen.
3. Tap the time field.
 - a. Tap the time format you prefer; “12 Hour” or “24 Hour”.
 - b. Tap the **NEXT** button. The display will go to the “Set Up Time” screen.
 - c. Using the up and down arrows, set the correct time.
 - d. Tap the **ACCEPT** button. The display will return to the “Set Up Date And Time” screen.
4. When you are satisfied with the date and time settings tap the **NEXT** button. The display will go to the “Set Up Location Info” screen.

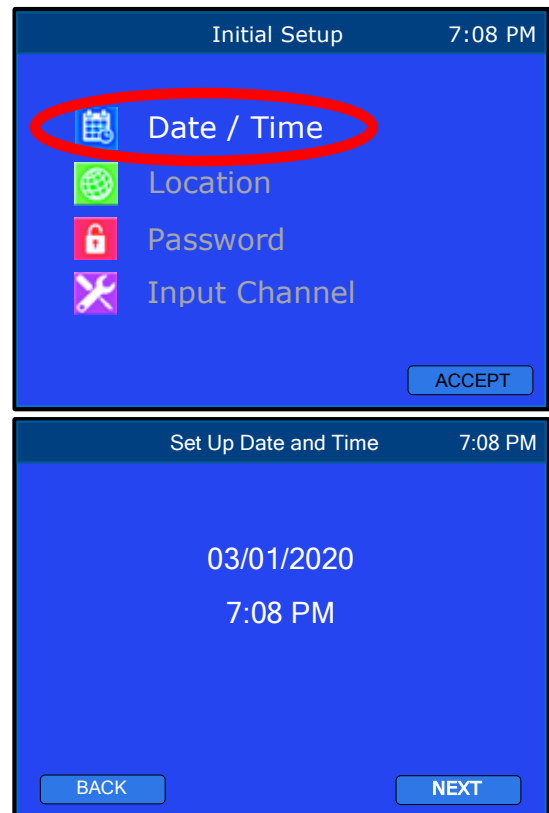

B. Location

The 900 allows you to enter user specific information such as device and/or sensor location. To enter location information from the “Set Up Location Info” screen:

1. Tap the box to the right of each field you wish to enter data in. An alphanumeric keypad will be displayed.
2. Enter the desired data (up to 9 characters per field) then tap “OK”.
3. When you are satisfied with the Location Info, tap the **NEXT** button. The display will go to the “Setup Password: Select User” screen, proceed to the password settings.



C. Set Up Password Security

The Password feature allows you to set password protection for different levels of access. Once the Administrator Password is set up, the Administrator will be able to limit the access of Operators to prevent unauthorized changes in settings / configuration.

The Password settings are optional; tap the **NEXT button to skip this setting during the Initial Setup. Password settings may be set up at a later time, for more detailed information, see DETAILED SYSTEM SETTINGS, Passwords and Security on page 53.**



Once the administrator password is set, it may only be reset using that password or by contacting the Myron L® Company.

Make sure the Administrator’s password is recorded in a secured location. If this password is lost the instrument CANNOT be reprogrammed without contacting the Myron L® Company.

1. Set Up Administrator Password.
 - a. Tap the “Administrator” field. The display will go to the “Set Up Security” screen.
 - b. Tap the “Setup Password” field.
 - c. Tap the “New Password” field.
 - d. Enter the Administrator Password, up to 8 characters, then tap “OK”.
 - e. Tap the “Confirm Password” field.
 - f. Re-enter the Administrator password then tap “OK”.
 - g. If you are satisfied with your password, tap the **ACCEPT** button. The display will return to the “Set Up Security” screen.
2. Set up Operator Access.
 - a. Tap the “Operator Access” field.
 - b. Tap the box to the left of each function you want operators to have access to.
 - Green box indicates allowed access.
 - Blue box indicates denied access.
 - c. When you are satisfied with the access settings, tap the **ACCEPT** button. The display will return to the “Set Up Security” screen.
 - d. Tap the **BACK** button. The display will return to the “Setup Password: Select User” screen.

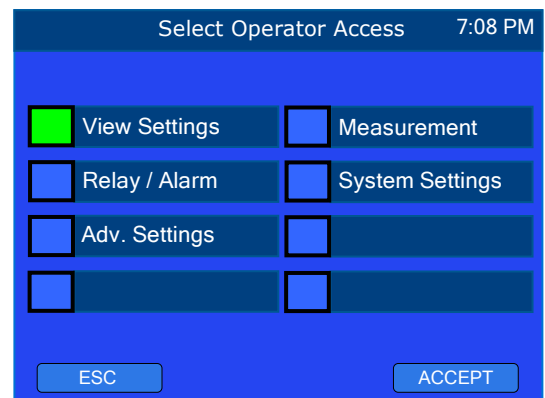
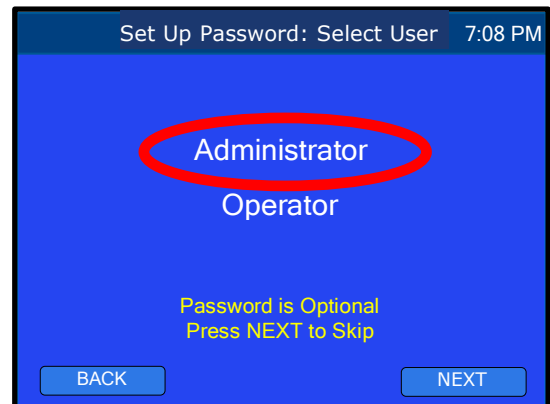

3. Set Up Operator Password.
 - a. Tap the “Operator” field. The display will go to the “Set Up Security” screen.
 - b. Tap the “Setup Password” field.
 - c. Tap the “New Password” field.
 - d. Enter the desired operator password, up to 8 digits, then tap “Enter”.
 - e. Tap the “Confirm Password” field.
 - f. Re-enter the operator password then tap “Enter”.
 - g. Tap the **ACCEPT** button.
 - h. Tap the **BACK** button. The display will return to the “Setup Password: Select User” screen.
 - i. Tap the **NEXT** button. Continue to Section D: “Enable/Disable Input Channels”.

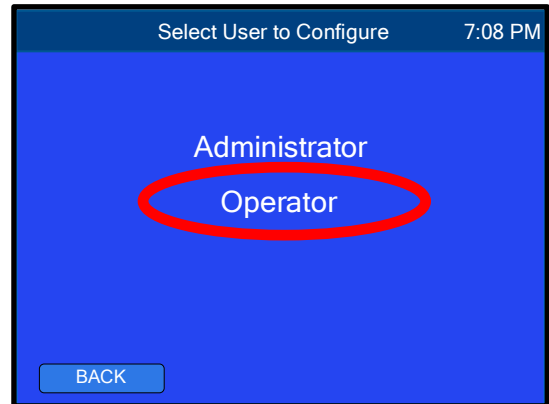

D. Enable/Disable Input Channels

Each connected sensor/input must be enabled prior to operation. This is done from the “Select Input Channel” screen. To enable (or disable) input channels from the “Select Input Channel” screen:

1. Tap the box to the left of each input channel you wish to enable.
 - Green box indicates the input channel is enabled.
 - Blue box indicates the input channel is disabled.

NOTE: Tapping the “Select All” box will select all input channels.
2. When you are satisfied with the status of each input channel, tap the **ACCEPT** button. The display will go to the “Select Screen Layout” screen.

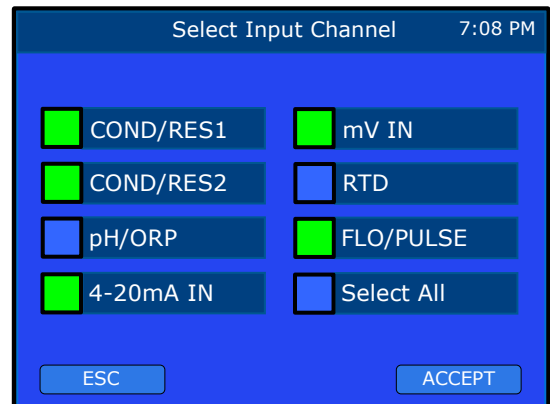

NOTE: See DETAILED OPERATING SETTINGS (Section VII) for instructions on setting up input channels (measurement types, sensor models, cell constants, set relays, etc...).

E. Screen Layout

The 900 allows you to customize the layout of the screen displayed during normal operating mode. This is done from the “Select Screen Layout” screen. Directly below are examples of the different operating screens available.

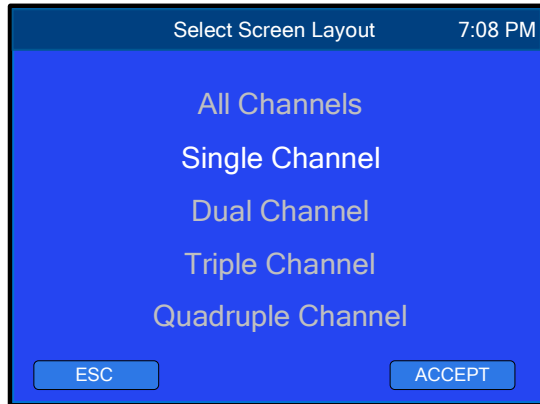

“Select Screen Layout” menu

Inputs		Outputs	
COND/RES1	1634 μ S	0-10V	7.87 V
COND/RES2	284.6 μ S	4-20mA	4.00mA
pH/ORP	7.16	Relay 1	Enabled
mV IN	835.7 mV	Relay 2	Enabled
RTD	23.2 $^{\circ}$ C	Relay 3	Enabled
4-20mA IN	13.45 mA	Alarm 1	Enabled
FLO/PULSE	1.45 gps	Alarm 2	Disabled

“All Channels” Screen Layout



“Single Channel” Screen Layout



“Dual Channel” Screen Layout



“Triple Channel” Screen Layout

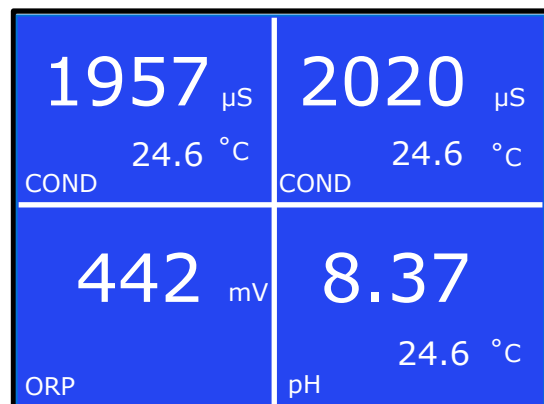

“Quadruple Channel” Screen Layout

To select the Screen Layout:

1. Tap on the desired screen layout. The text of the selected option will turn white.
2. Tap the **ACCEPT** button.
3. The 900 will go directly into normal Operating Mode (see Normal Operating Screen, below).

Upon initial activation, the 900 will populate the display locations with enabled input channels.

NOTE: If the Single Channel screen layout is selected the display will alternate between enabled input channels. To stop the screen on a specific input channel, simply tap the lock on the bottom right side of the screen.

See DISPLAY SETTINGS (page 57) for instructions on rearranging the display configuration, display brightness, etc....

Normal Operating Screen
(Example below is a Single Channel screen layout)

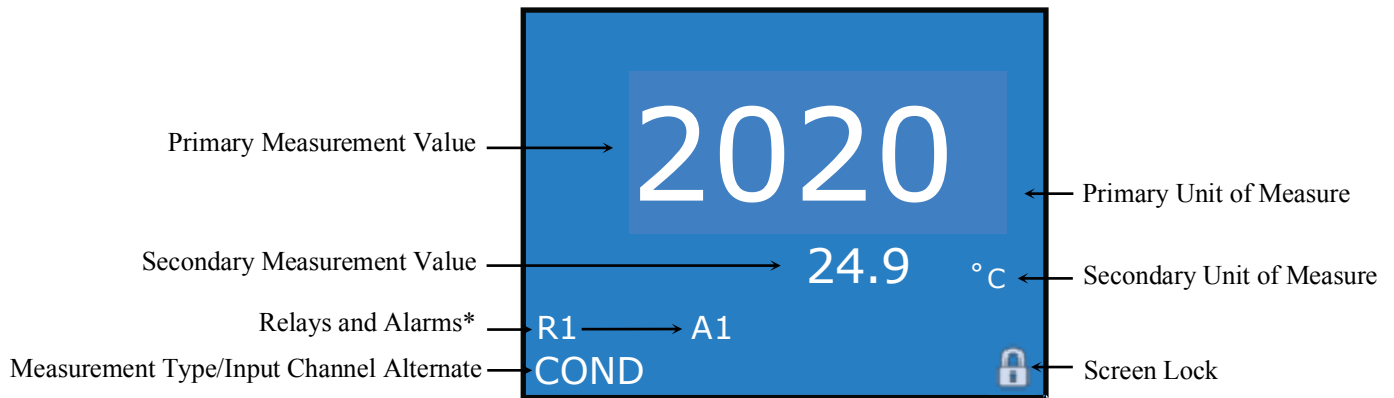

* Relays and Alarms that are linked to the current input channel will be displayed here regardless of their status (enabled or disabled). If the screen is set to Dual, Triple, or Quadruple Channel layout, the linked relay(s) and alarm(s) will alternate.

For detailed information on the “All Channels” operating screen, see DISPLAY SETTINGS / All Channels Screen Layout, page 59.

The Initial Setup is completed. See DETAILED OPERATING SETTINGS (page 37) to set up sensors, select measurement types, set up relays, etc....

VI. DETAILED OPERATING SCREEN

The “Detailed Operating Screen” will display the basic settings of the selected input channel. This screen is the base point from which all settings are accessed after the initial setup.

To access the “Detailed Operating Screen” from normal Operating Mode, simply tap the measurement value of the input channel you wish to view/edit.

NOTE: If the input channel you wish to view/edit is not displayed on the normal Operating Screen, you can tap on any measurement value to access the “Detailed Operating Screen”, tap the **ADJUST** button to enter EDIT Mode, then simply tap the left or right arrows until the input channel you wish to view/adjust is displayed in the top center of the screen. The “About” page, “System Settings”, “Display Settings”, “Advanced Settings”, and “System Overview” screen may be accessed from any “Detailed Operating Screen” by tapping the **SETTINGS** button.

Tapping the **ADJUST** button turns EDIT Mode on and off. While in EDIT Mode the text of the editable fields will be white (indicating they are editable) and when EDIT Mode is off the text is gray (indicating they are no longer editable). To return to the normal operating screen, while EDIT Mode is off, tap the gray measurement value.

While in EDIT Mode, the following items may be available for setup / adjustment (depending on input channel selected):

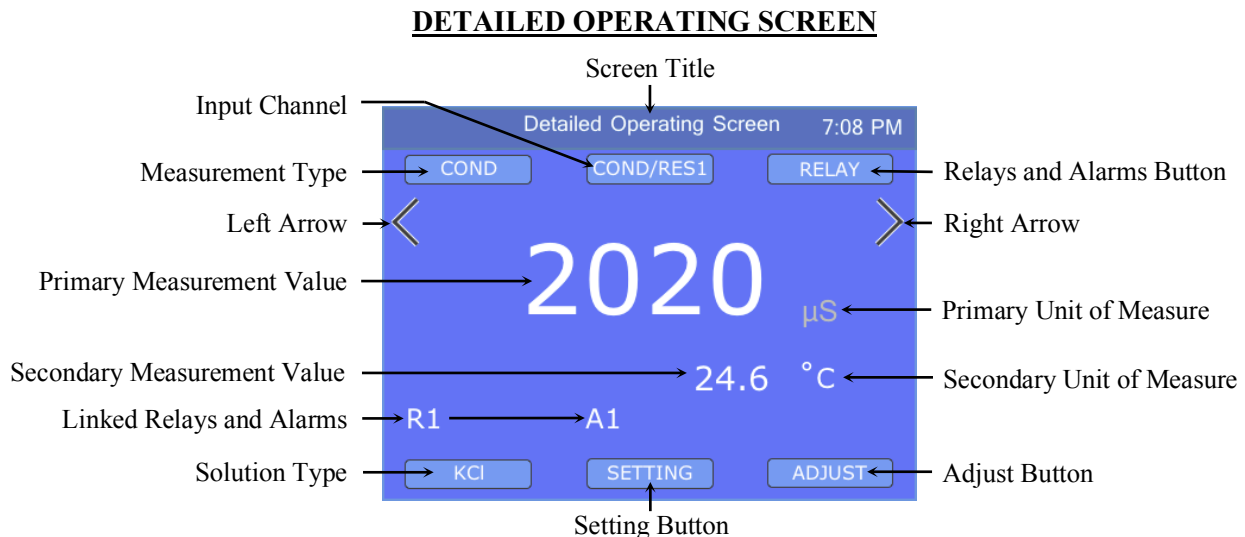

- **Screen Title:** Indicates the title of the current screen.
- **Input Channel:** Indicates which input channel is selected. When in EDIT Mode, tapping this button brings you to the sensor selection/settings screens.
- **Measurement Type:** Indicates the measurement type selected for the current input channel.
- **Left Arrow:** Tapping this arrow brings you to the previous input channel’s “Detailed Operating Screen”.
- **Primary Measurement Value:** Displays the primary measurement value associated with the current input channel.
- **Secondary Measurement Value:** Displays the secondary measurement value associated with the current input channel.
- **Linked Relays and Alarms:** Indicates any relay(s) and/or alarm(s) linked to the current input channel regardless of their status (enabled and disabled).
- **Solution Type:** Indicates the solution type selected for temperature compensation (if applicable).
- **Settings Button:** When in EDIT Mode, tapping the **SETTINGS** button brings you to the main settings menu.

- **Relays and Alarms Button:** When in EDIT Mode, tapping this button brings you to the Relay/Alarm setting menu.
- **Right Arrow:** Tapping this arrow brings you to the next input channel’s “Detailed Operating Screen”.
- **Primary Unit of Measure:** Displays the unit of measure for the primary measurement.
- **Secondary Unit of Measure:** Displays the unit of measure for the secondary measurement.
- **Adjust Button:** Tapping this button turns EDIT Mode on/off.

VII. DETAILED OPERATING SETTINGS

A. Conductivity, Resistivity, TDS or Salinity

Input Channels: COND/RES1 and COND/RES2

1. Sensor Settings

Sensor Settings will allow you to select:

- Sensor Models
- Cable Length
- Length Unit
- Ω /Length (cable resistance)
- Cell Constant

To enter Sensor Settings from the COND/RES1 or COND/RES2 “Detailed Operating Screen”:

1. Tap the **ADJUST** button to enter EDIT Mode.
2. Tap the input channel button on the top center of the screen. The display will go to the “Select Sensor” screen with the sensors available for the selected input channel.
3. Select the sensor:
 - a. Using the up and down arrows, select the sensor model connected to the current input channel.
 - b. Tap the **ACCEPT** button. The display will go to the “Sensor Settings” screen.
4. Adjust cable settings for a custom cable (or skip to Line 5).
 - a. Tap the “Cable Length” field, type in the length of the sensor cable then tap “Enter”.
 - b. Tap the “Length Unit” field, select either ft (feet) or m (meter), then tap the **ACCEPT** button.
 - c. Tap the “ Ω /Length” field, type in the correct resistance per unit then tap “Enter”.
 - Myron L[®] Company conductivity, resistivity, TDS, and salinity sensor cables are 0.01614 Ω /ft or 0.05295 Ω /m.
5. Enter the cell constant:

The cell constant can be found on the label on the sensor cable. It is the number preceded by “K=”. Example shown to the right is “0.05”.

 - a. Tap the “Cell Constant” field.
 - b. Enter the cell constant, then tap “Enter”.
6. Tap the **ACCEPT** button to accept settings and return to the “Detailed Operating Screen”.

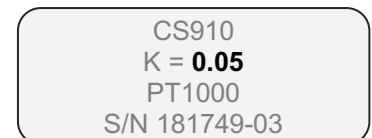
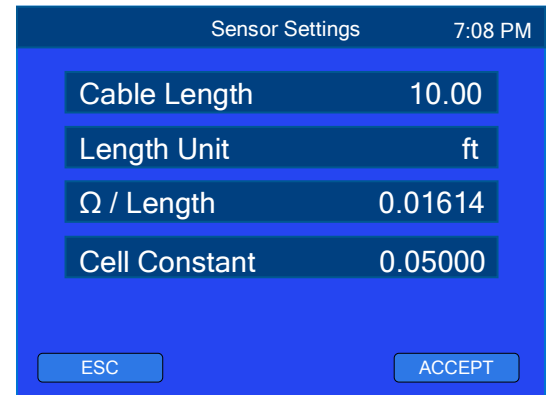
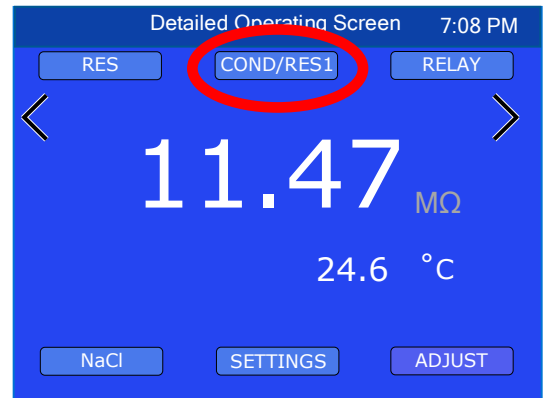

2. Select Measurement Type

Measurement type options are:

- COND – Conductivity
- RES – Resistivity
- TDS – Total Dissolved Solids
- SAL – Salinity

To select the measurement type from the desired input channel's "Detailed Operating Screen":

1. Tap the **ADJUST** button to enter EDIT Mode.
2. Tap the Measurement Type button on the upper left side of the screen. The display will go to the "Select Measurement Type" screen with the available measurement types.
3. Tap the desired measurement type. The text of the selected measurement type will turn white.
4. Tap the **ACCEPT** button. The display will return to the "Detailed Operating Screen".



NOTE: All relay(s)/alarm(s) and/or output signals associated with an input channel will be disabled if the measurement type for that input channel is changed or the input channel is disabled.

NOTE: When you change the measurement type, the solution type will automatically update to the default.

3. Select Solution Type

Why Solution Selection is Available:

The conductivity of solution changes with temperature and these changes differ depending on the makeup of the solution. The Solution Type determines the temperature correction of conductivity and the calculation of TDS from compensated conductivity (ref. Conductivity Conversion to Total Dissolved Solids (TDS), page 85).

The 900 Series conductivity, resistivity, TDS, and salinity measurements utilize temperature correction referenced to 25°C. The Solution Type determines the salt solution characteristic (temperature coefficient) used to determine what the value of the solution would be at 25°C.

The 4 Solution Types (KCl, NaCl, 442™, and USER):

On the bottom left side of the "Detailed Operating Screen" is the Solution Type used to model temperature compensation for that input channel. Generally, using KCl for conductivity, NaCl for resistivity and salinity, and 442™ for TDS will reflect present industry practice for standardization. These are the default solution types for each measurement type.

For User Mode settings see Advanced Settings; Section D: "User Mode Tempco and Ratio Settings (Conductivity, Resistivity, TDS, or Salinity)" in on page 66.

a) Selecting KCl, NaCl, or 442 Solution Types

To adjust solution type from the desired input channel's "Detailed Operating Screen":

1. Tap the **ADJUST** button to enter EDIT Mode.
2. Tap the Solution Type button on the lower left side of the screen.
3. Tap the desired solution type (KCl, NaCl, or 442). The text of the selected solution type will turn white.
4. Tap the **ACCEPT** button. The display will return to the "Detailed Operating Screen".

NOTE: There is a separate calibration for each of the 4 solution types as well as each input channel. (See the CALIBRATION Section on page 68).

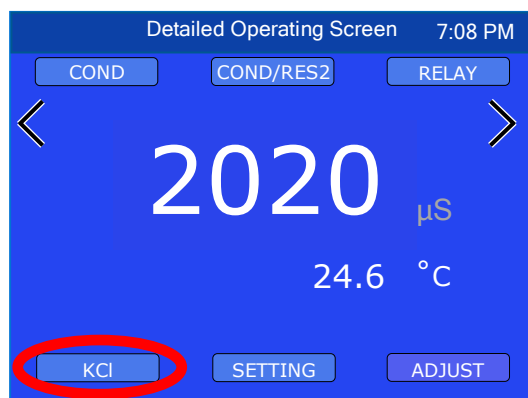

B. pH/ORP (Pre-amplified)
Input Channel: pH/ORP

The pH/ORP input channel is intended for use with Myron L® Company pre-amplified pH and ORP sensors. These sensors contain precision circuitry that increases the accuracy and permit application of the sensors over greater distances. All Myron L® Company pre-amplified pH and ORP sensors contain a precision 1000Ω RTD for increased temperature accuracy.

1. Sensor Settings, pH/ORP

Sensor Settings will allow you to select:

- Sensor Model
- Cable Length
- Length Unit
- Ω/Length (cable resistance)

To enter Sensor Settings from the pH/ORP “Detailed Operating Screen”:

1. Tap the **ADJUST** button to enter EDIT Mode.
2. Tap the Input Channel button on the top center of the screen. The display will go to the “Select Sensor” screen with the sensors available for the pH/ORP input channel.
3. Using the up and down arrows, select the sensor connected to this input channel.
4. Tap the **ACCEPT** button.
5. The display will go to the “Sensor Settings” screen.
6. The default Cable Length, Length Unit, and Ω/Length for the selected sensor will be automatically populated.
 - a. To adjust for a custom cable:
 - i. Tap the “Cable Length” field.
 - ii. Enter the length of the sensor cable then tap “Enter”.
 - iii. Tap the “Length Unit” field, select either “ft” for feet or “m” for meter then tap “Enter”.
 - iv. Tap the “Ω/Length” field, type in the correct resistance per unit then tap “Enter”.
 - Myron L® Company pre-amplified pH and ORP sensor cables are 0.02567 Ω/ft or 0.08422 Ω/m.
7. Tap the **ACCEPT** button to accept settings and return to the “Detailed Operating Screen”.

2. Select Measurement Type

Measurement options are:

- ORP – Oxygen Reduction Potential/Redox
- pH – pH with temperature compensation
- pH (TC Off) – pH without temperature compensation
- mV – Generic mV Sensor

The measurement options displayed will depend on which sensor was selected in Step 1.

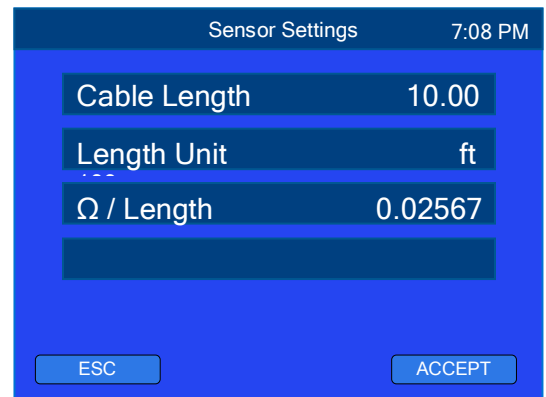
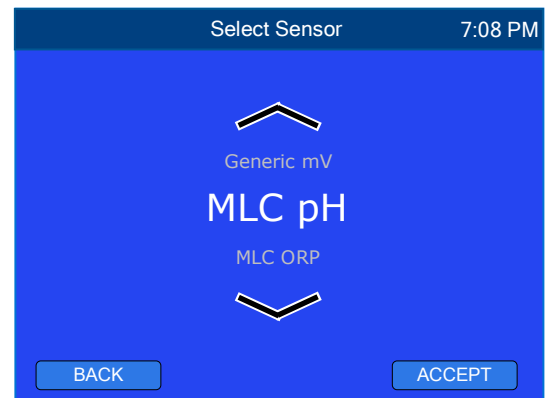
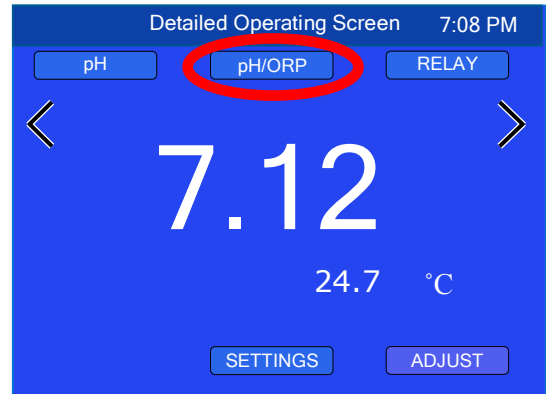

To select the measurement type from the pH/ORP “Detailed Operating Screen”:

1. Tap the **ADJUST** button to enter EDIT Mode.
2. Tap the Measurement Type button on the upper left side of the screen. The display will go to the “Select Measurement Type” screen with the available measurement types for the selected sensor.
3. Tap the desired measurement type. The text of the selected measurement type will turn white.
4. Tap the **ACCEPT** button. The display will return to the “Detailed Operating Screen”.

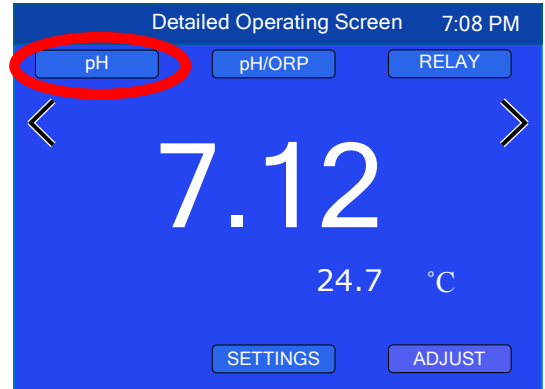

NOTE: If the desired measurement type is not available, verify you have selected the correct sensor in Step 1 (Sensor Settings). The example to the right shows the measurement types available if an “MLC pH” sensor was selected in Step 1.

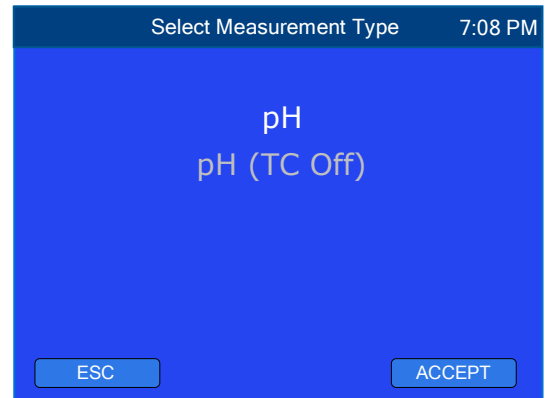

C. mV Input (BNC)
Input Channel: mV IN

1. Select Measurement Type

Measurement options are:

- ORP – Oxygen Reduction Potential/Redox
- pH – pH with temperature compensation¹
- pH (TC Off) – pH without temperature compensation

To select the measurement type from the mV IN “Detailed Operating Screen”:

1. Tap the **ADJUST** button to enter EDIT Mode.
2. Tap the Measurement Type button on the upper left side of the screen. The display will go to the “Select Measurement Type” screen with the available measurement types for the mV IN input channel.
3. Tap desired measurement type. The text of the selected measurement type will turn white.
4. Tap the **ACCEPT** button. The display will return to the “Detailed Operating Screen”.

¹For pH with temperature compensation, a temperature sensor must be installed in the RTD input and the RTD input channel must be enabled or the pH reading will be dashed out.

NOTE: The shorting BNC connector cap (included with your 900) must be installed on the BNC connector when there is no sensor connected to the mV IN input.

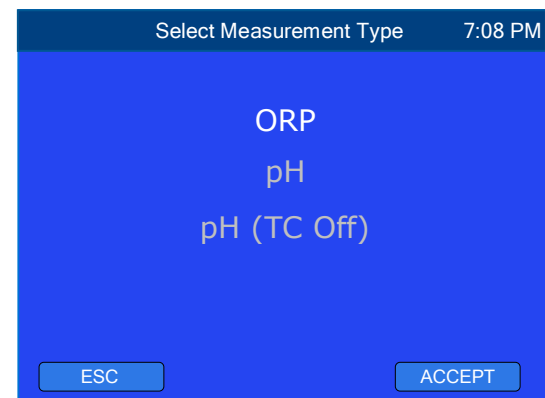
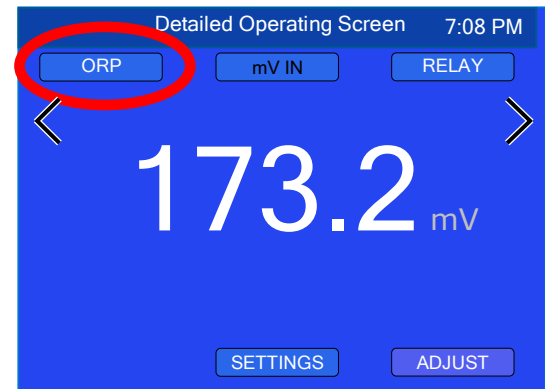

D. RTD Temperature Input

Input Channel: RTD

The RTD sensor settings allow you to customize the following:

- Cable Length
- Length Unit
- Ω / Length (cable resistance)

To set up the RTD input from the RTD “Detailed Operating Screen”:

1. Tap the **ADJUST** button to enter EDIT Mode.
2. Tap the Input Channel button on the top center of the screen.
3. Tap the “Cable Length” field.
4. Using the keypad, enter the cable length then tap “Enter”.
5. Tap the “Length Unit” field.
6. Select the length unit “ft” for feet or “m” for meter, the text of the selected unit will turn white, then tap the **ACCEPT** button.
7. Tap the “ Ω / Length” field.
8. Using the keypad, enter the cable resistance then tap “Enter”.
 - The Myron L® Company model ITS1 temperature sensor cable resistance is 0.01614 Ω /ft or 0.05295 Ω /m
9. If you are satisfied with the settings, tap the **ACCEPT** button.

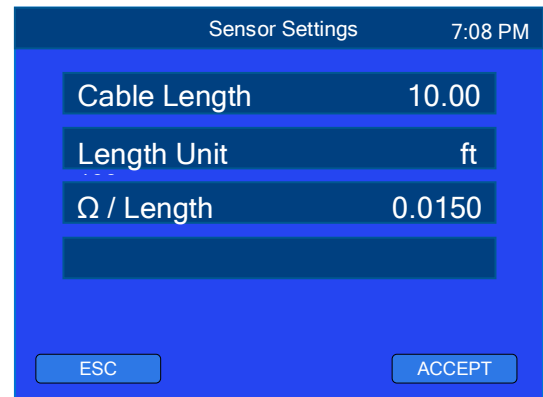
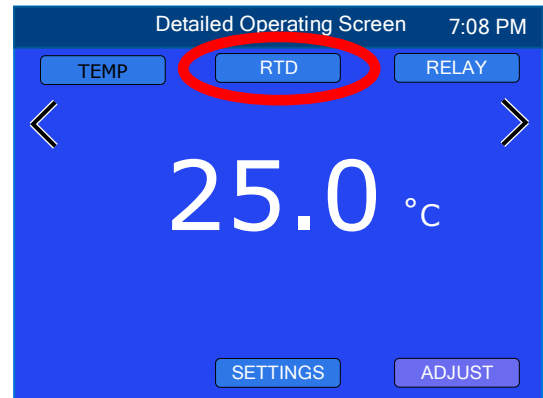

E. Temperature Unit of Measure

The 900 allows you to select which unit of measure the temperature readings will be displayed in; °C (degrees Celsius) or °F (degrees Fahrenheit).

The temperature unit selection is global and can be changed from any “Detailed Operating Screen” with a temperature reading. All temperatures displayed will be in the same unit.

To change temperature units:

1. Tap the **ADJUST** button to enter EDIT Mode.
2. Tap the temperature unit on the screen. The display will go to the “Select Unit of Temperature” screen.
3. Tap the temperature unit you prefer (the text of selected unit will be white).
4. Tap the **ACCEPT** button.
5. The display will return to the “Detailed Operating Screen”. Continue with additional settings or tap the gray measurement value to return to the “Operating” screen.

NOTE: Conductivity/Resistivity/TDS/Salinity User mode temperature compensation will always be set in %/°C.

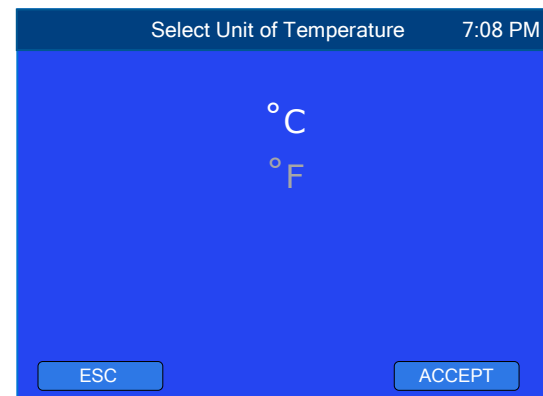
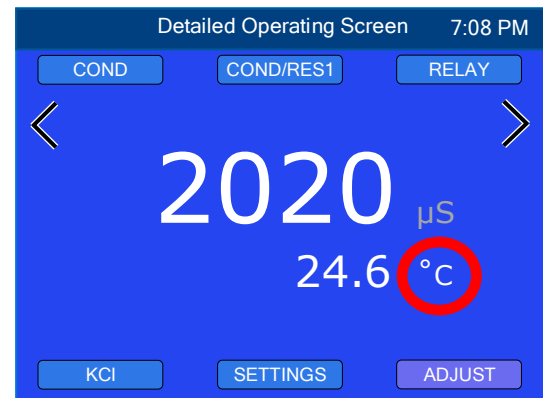

F. 4-20 mA Input

Input Channel: 4-20 mA IN

The 4-20 mA input is standard on all 900 Series models and allows the flexibility of connecting almost any 4-20 mA sensor, transmitter, or external device that transmits a 4-20 mA or 0-20 mA current. The 900 allows the user to select the desired units and range of measurement for display.

1. Select Measurement Type

Measurement options are:

- CURRENT – Displays 0-20/4-20mA signal.
- MEAS (Measurement) – Displays current signal translated into selected units in larger font on top and the actual current in smaller font below.

To select the measurement type from the 4-20 mA IN “Detailed Operating Screen”:

1. Tap the **ADJUST** button to enter EDIT Mode.
2. Tap the Measurement Type button on the upper left side of the screen. The display will go to the “Select Measurement Type” screen.
3. Tap the desired measurement type.
4. Tap the **ACCEPT** button.
 - If **CURRENT** was selected the display will return to the “Detailed Operating Screen”. Continue with additional settings or tap the gray measurement value to return to the normal operating screen.
 - If **MEAS** was selected the display will go to the “Set Up 4-20 mA Input” screen. Continue on to Step 2: “Measurement Settings, 4-20 mA” below.

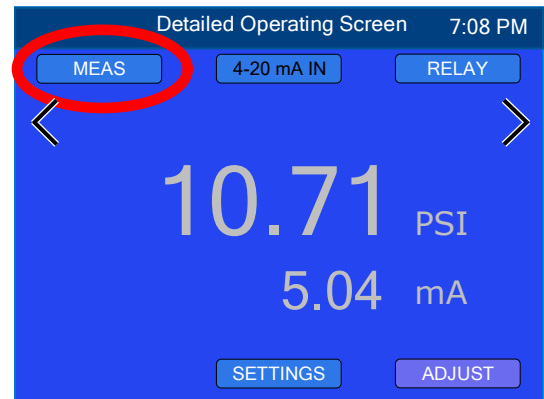
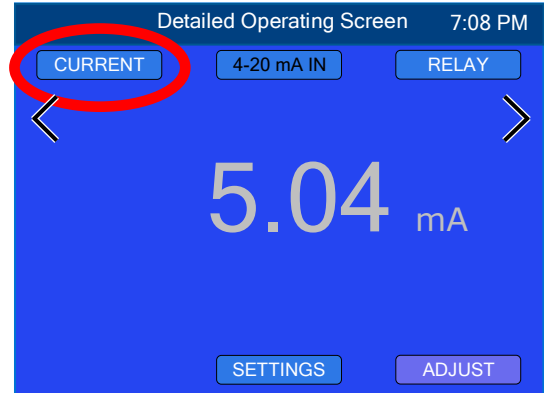

2. Measurement Settings, 4-20 mA

In Measurement mode, the 4-20 mA input will allow you to select:

- 0-20 or 4-20 mA Signal Input
- Unit of Measure to Display
 - Unit of measure options: mA, Hz, kHz, gps, gpm, gph, lps, lpm, lph, Gal, Ltr, %, PSI, NTU, μ S, mS, ppm, ppt, mV, V, °C, °F, Ω , k Ω , and M Ω .
- Full Scale Value
- Zero Scale Value

The first time the 4-20mA Input is set up, it will prompt you through each setting. For changes after the initial setup, simply tap the field you wish to change.

To set up 4-20 mA Input in Measurement mode:

1. Tap the “0-20 or 4-20” field.
2. Tap the desired input range, “4-20 mA” or “0-20 mA” then tap the **NEXT** button.
3. Using the up and down arrows, select the desired measurement unit, then tap the **NEXT** button.
4. Using the keypad, enter the Zero Scale value then tap “Enter”.
5. Using the keypad, enter the Full Scale value then tap “Enter”.
6. If you are satisfied with the measurement settings, tap the **BACK** button.

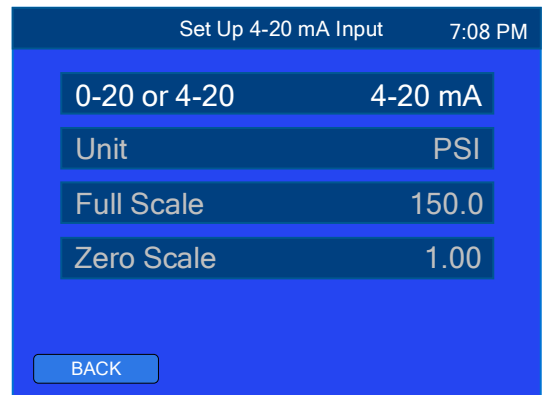

G. Flow / Pulse Input

Input Channel: FLO/PULSE

For use with most flow/pulse sensors, the 900 displays flow rate and volume or pulse frequency.

1. Sensor Settings, Flow/Pulse Input

Flow sensor settings require the following settings:

- K-factor Value
- K-factor Unit
- Volume Unit
- Time Unit
- Mechanical (status)*

To set up the flow sensor settings from the FLO/PULSE “Detailed Operating Screen”:

1. Tap the **ADJUST** button to enter EDIT Mode.
2. Tap the Input Channel button on the top center of the screen. The display will go to the “Set Up Flow Rate” screen.
3. Tap the “K-factor Value” field.
4. Using the keypad, enter the K-factor Value then tap “Enter”.
5. Tap the “K-factor Unit” field.
6. Select the K-factor unit then tap the **ACCEPT** button.
7. Tap the “Volume Unit” field.
8. Select the Unit of Volume then tap the **ACCEPT** button.
9. Tap the “Time Unit” field.
10. Select the Unit of Time then tap the **ACCEPT** button.
11. Tap the “Mechanical” field.
12. Select the desired status then tap the **ACCEPT** button*.
13. If you are satisfied with the settings, tap the **BACK** button.
14. The display will return to the “Detailed Operating Screen”.

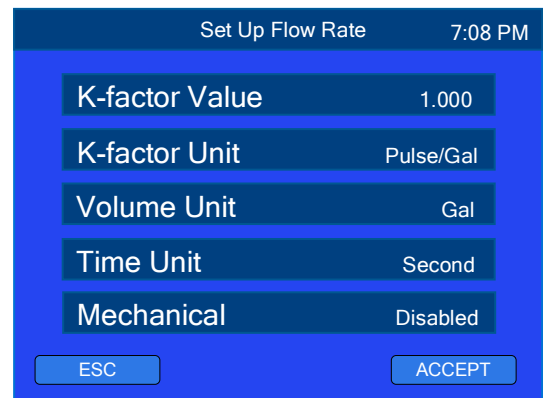
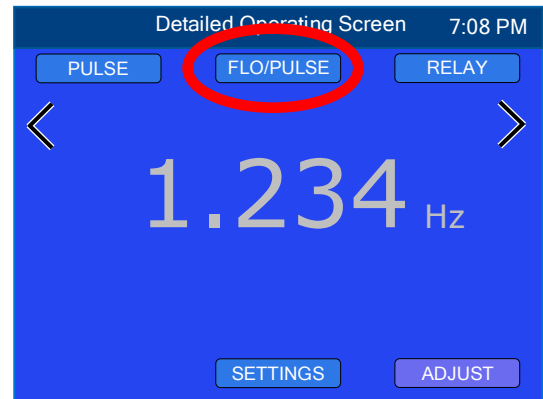

* With Mechanical mode enabled, the 900 filters contact bounce associated with mechanical switches and changes frequency range to 0.1-100 Hz.

2. Select Measurement Type

Measurement options are:

- FLOW – Displays the flow rate in larger font with the volume displayed in smaller font below.
- VOLUME – Displays the volume in larger font with the flow rate displayed in smaller font below.
- PULSE – Displays pulse frequency in Hz/KHz.

To select the measurement type from the FLO/PULSE “Detailed Operating Screen”:

1. Tap the **ADJUST** button to enter EDIT Mode.
2. Tap the Measurement Type button on the upper left side of the screen. The display will go to the “Select Measurement Type” screen.
3. Tap the desired measurement type.
4. Tap the **ACCEPT** button. The display will return to the “Detailed Operating Screen”.

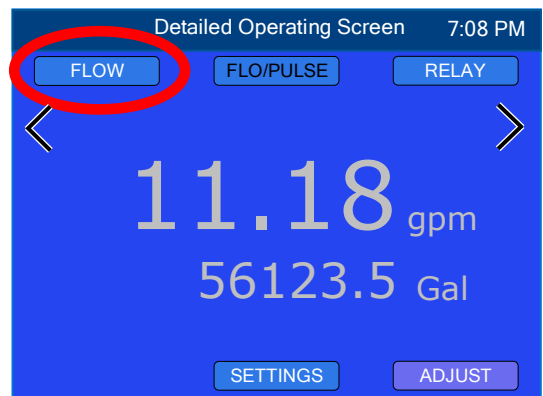

3. Volume Reset

Note: This action is irreversible and the previous total/volume will be irretrievable.

To reset the counter for total volume from the FLO/PULSE “Detailed Operating Screen”:

1. Tap the **ADJUST** button to enter EDIT Mode.
2. Tap the total/volume value. The display will go to the “Reset Count?” screen.
3. Tap the **RESET** button to accept the volume reset and return to the “Detailed Operating Screen”.

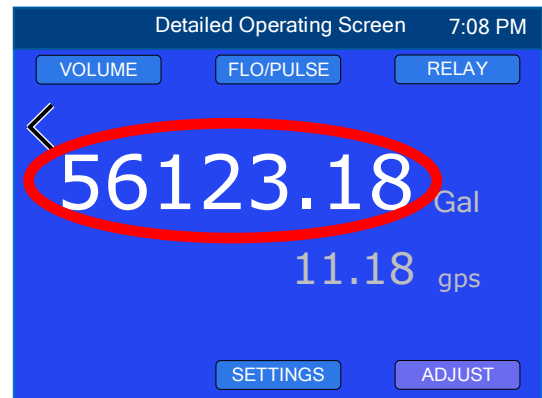

H. Flow Switch Input

Input Channel: FLOW SW

The Flow Switch Input, when triggered, will disable ALL relay outputs if there is a loss of flow in the system.

NOTE: Flow switches may also be installed (electrically connected) in-line with relay connections (see Relay Connection Section on next page).

If a flow switch is NOT directly connected to the 900, then a jumper (included) must be installed across the flow switch input connector.

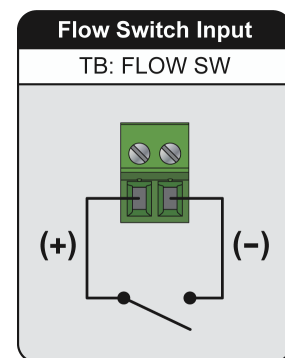

I. Relays and Alarms

The relays and alarms operate independently but may be programmed to work in conjunction. Relays and alarms may be set to trigger on measurement values rising above, falling below, In Window (within an upper and lower range of values), or Out Window (outside an upper and lower range of values) for any of the input channels or for derived % rejection. For more detailed information on trigger types, set points and hysteresis, see “Relay and Alarm Trigger, Set Point and Hysteresis Functionality” in the Reference Information Section on page 90.

While setting up Relay(s)/Alarm(s), you will be required to set hysteresis values for each set point. By tapping the **DEFAULT** button, the 900 will automatically enter 100 mV for ORP or 5% of the set point value for all other measurement types. Alternatively, you may enter custom hysteresis values for any or all set points. The acceptable hysteresis range for ORP is 2-100 mV, or 0.30-5.00% for all other measurement types. Entering hysteresis values beyond the specified range will result in an ERROR message.

CAUTION: Under normal conditions the default hysteresis values should be sufficient. However, if you wish to enter custom hysteresis values, please keep the following in mind:

- Adjusting the hysteresis too narrow, the 900 system will be susceptible to fluctuation due to irregular flow rate, chemical mixing or bubbles causing the relay to chatter.
- This condition is to be avoided, as it could damage your valves, pumps, etc....

The following cases will show an error message:

- Set point that is out of measurement range
- Hysteresis that is too high or too low
- The “High Set Point” is smaller than the “Low Set Point” (In Window/Out Window triggers only)

NOTE: All relay(s)/alarm(s) and/or output signals associated with an input channel will be disabled if the measurement type for that input channel is changed or the input channel is disabled.

1. Relay Wiring Options

a) Relay Connections

Myron L® Company 900 Series Multi-Parameter Monitor/Controllers are equipped with “Dry Contact” relay(s) which are designed to energize/de-energize when the set point is crossed. (See “Relay Settings” on page 46, for trigger and set point adjustment procedures) The relay energizes on increasing or decreasing readings as programmed by the user.

When energized (beyond set point), the Common (COM) will disconnect from the Normally Closed (NC) contact and connect to the Normally Open (NO) contact. Devices may be operated using either the Normally Open contact or Normally Closed contact; or both relay contacts may be used to control two devices of the same voltage.

NOTE: A flow switch may be installed (electrically connected) utilizing one of two convenient methods; the Flow Switch (FLOW SW) input connection, see Flow Switch Input, page 44, or in-line with a relay connection, see images below. If there is no flow switch connected to the 900 FLOW SW input, the jumper must be installed across the flow switch input connector.

The easiest method of connecting the relay is shown in the image to the right. This shows how the dry contact relay can use incoming power to activate a controlled device (alarm, solenoid valve, etc.) of 8 amps or less.

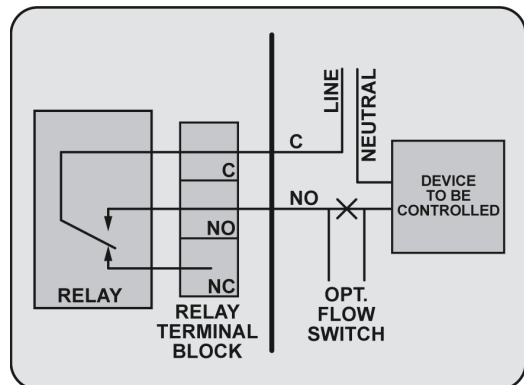

For 24 VAC applications, the Myron L® Company offers a 115 VAC to 24 VAC transformer, Model #VR. Other voltages must be user-supplied.

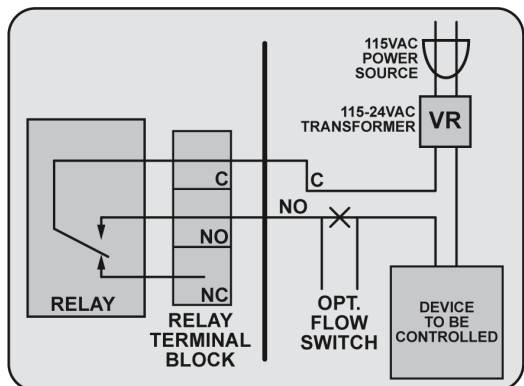

To avoid a possible hazardous condition:

- Make sure any device connected to the 900 Series relay outputs is sufficiently rated to handle load and voltage required by the device to be controlled.
- Make sure that the wiring used to connect any device to the 900 Series Monitor/Controller relay outputs is at least 14 AWG.

Connect the user supplied relay interface cable to the Monitor/Controller’s terminal block connectors, see image below.

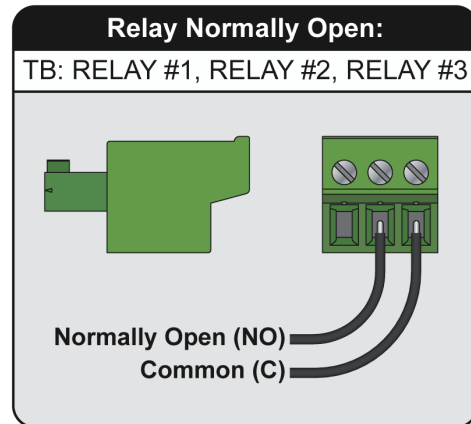
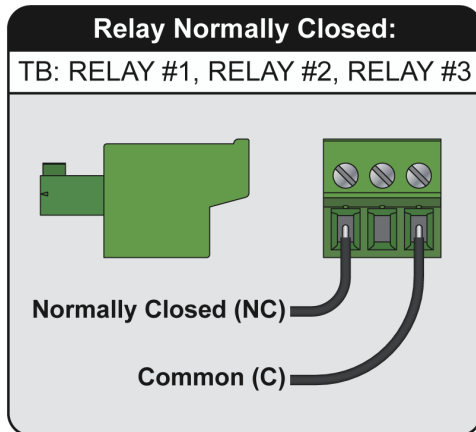

Connecting both power source leads to the relay terminal block connectors will damage the circuit board and may cause personal injury.

2. Relay Settings

The first time a relay is set up, the 900 will prompt you through all the required settings; status, input channel, trigger, set point and hysteresis. Subsequent changes to a relay’s settings will allow you to select only those fields you wish to change.

Setpoint and hysteresis values will always be entered in the lowest measurement unit available for the measurement type. Example 25 mS would be entered as 25000 μ S and 13 M Ω would be entered as 13000 k Ω . The display will automatically adjust to the correct unit of measure for the value entered.

To set up a relay from any “Detailed Operating Screen”:

1. Tap the **ADJUST** button to enter EDIT Mode.
2. Tap the **RELAY** button on the top right side of the screen.
3. Tap the relay you wish to configure.
4. Tap the “Status” field.
5. Tap the desired status.
 - If **Disable** was selected, tap the **ACCEPT** button. The display will return to the “Set Up Relay [#]” screen. Tap the **BACK** button to return to the “Select Relay/Alarm” screen and continue setting up additional relays/alarms or tap the **BACK** button again to exit.
 - If **Enable** was selected, tap the **NEXT** button on the bottom right side of the screen and continue to Line 6.
6. Using the up and down arrows, select the desired input channel, then tap the **NEXT** button.
7. Tap the desired trigger type then tap the **NEXT** button.

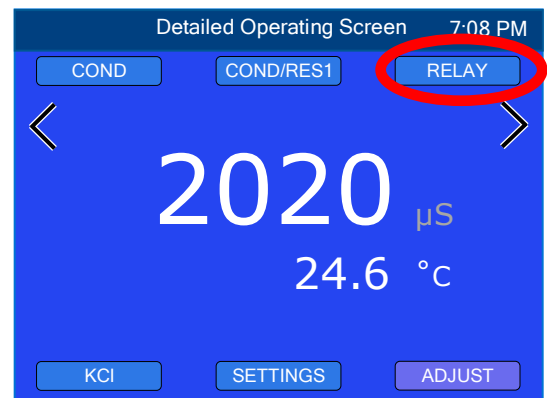

8. Enter set point(s) and hysteresis:
 - a. Enter the set point:
 - i. Tap the “Set Point” field.
 - ii. Type in the desired set point.
 - iii. Tap “Enter”.
 - b. Enter the hysteresis:

Tap the **DEFAULT** button to automatically enter the default hysteresis.

- Or -

 - i. Tap the “Hysteresis” field.
 - ii. Type in the desired hysteresis.
 - iii. Tap “Enter”.

NOTE: If “In Window” or “Out Window” trigger was selected repeat Steps “a” and “b” above for High and Low set points and hysteresis.

9. Tap the **ACCEPT** button to accept the set point configuration. The display will return to the “Set Up Relay [#]” screen.

Once a relay has been set up the “Set Up Relay [#]” screen will show the current status, input channel, trigger type and set point(s). If trigger type is “In Window” or “Out Window”, the set point values shown on this screen will alternate between High and Low set points.
10. If you are satisfied with the relay settings, tap the **BACK** button. The display will return to the “Select Relay/Alarm” screen. Continue setting up additional relays/alarms or tap the **BACK** button to exit relay/alarm settings and return to the “Detailed Operating Screen”.

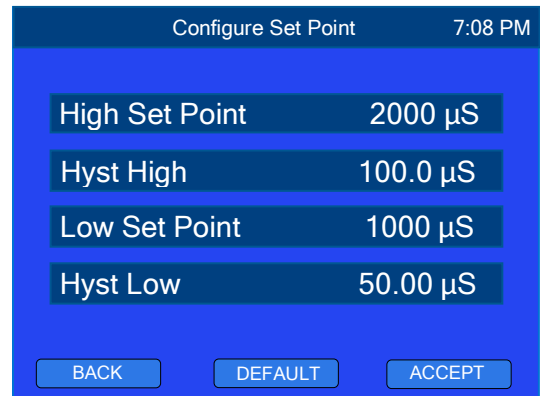
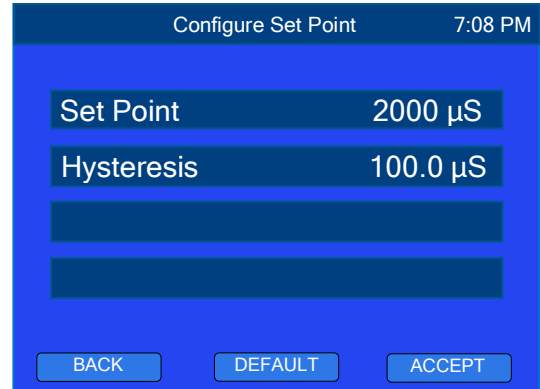

NOTE: With “In Window” or “Out Window” triggers selected, tapping the **DEFAULT** button for hysteresis will reset both high set point hysteresis and low set point hysteresis to default values based on set point values entered.

3. Alarm Settings

The first time an alarm is set up, the 900 will prompt you through all the required settings; status, input channel, trigger, set point, hysteresis, and Latching status. Subsequent changes to an alarm’s settings will allow you to select only those fields you wish to change.

To set up an alarm from any “Detailed Operating Screen”:

1. Tap the **ADJUST** button to enter EDIT Mode.
2. Tap the **RELAY** button on the top right side of the screen.
3. Tap the alarm you wish to configure.
4. Tap the “Status” field.
5. Tap the desired status.
 - If **Disable** was selected, tap the **ACCEPT** button. The display will return to the “Set Up Alarm [#]” screen. Tap the **BACK** button to return to the “Select Relay/Alarm” screen and continue setting up additional relays/alarms or tap the **BACK** button again to exit.
 - If **Enable** was selected, tap the **NEXT** button on the bottom right side of the screen and continue to Line 6.



6. Using the up and down arrows, select the desired input channel, then tap the **NEXT** button.
7. Tap the desired trigger type then tap the **NEXT** button.
8. Enter set point(s) and hysteresis:
 - a. Enter the set point:
 - i. Tap the “Set Point” field.
 - ii. Type in the desired set point.
 - iii. Tap “Enter”.
 - b. Enter the hysteresis:

Tap the **DEFAULT** button to automatically enter the default hysteresis.

- or -

 - i. Tap the “Hysteresis” field.
 - ii. Type in the desired hysteresis.
 - iii. Tap “Enter”.

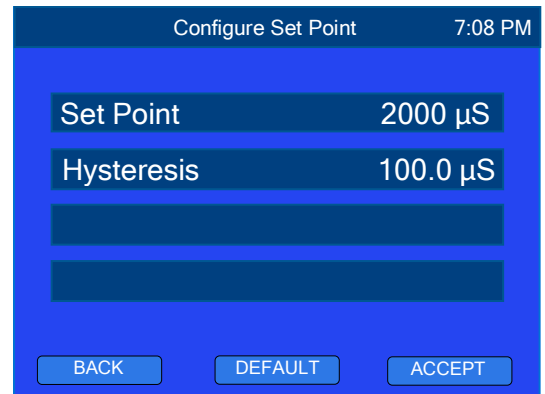

NOTE: If “In Window” or “Out Window” trigger was selected repeat Steps “a” and “b” above for High and Low set points and hysteresis.

9. Tap the **NEXT** button.
10. Set Latching status (Enable or Disable)

NOTE: If latching is enabled, once an alarm is triggered, it must be manually turned off/reset at the 900 display, even if the reading returns to desired levels.

 - a. Tap the desired Latch status.
 - b. Tap the **ACCEPT** button. The display will return to the “Set Up Alarm [#]” screen.

Once an alarm has been set up the “Set Up Alarm [#]” screen will show the current status, input channel, trigger type and set point(s). If trigger type is “In Window” or “Out Window”, the set point values shown on this screen will alternate between High and Low set points.

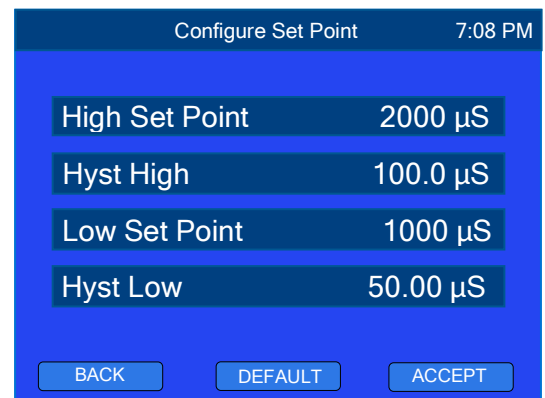

11. If you are satisfied with the alarm settings, tap the **BACK** button. The display will return to the “Select Relay/Alarm” screen. Continue setting up additional relays/alarms or tap the **BACK** button to exit relay/alarm settings and return to the “Detailed Operating Screen”.

NOTE: With “In Window” or “Out Window” triggers selected, tapping the **DEFAULT** button for hysteresis will reset both high set point hysteresis and low set point hysteresis to default values based on set point values entered.

4. Reset Latching Alarms

An alarm that is set to latch must be manually turned off at the 900 after the value has returned to the normal operating range.

To reset an alarm that has triggered, and is set to Latch:

1. From the “Detailed Operating Screen”, tap the **ADJUST** button to enter EDIT Mode.
2. Tap the **RELAY** button on the top right side of the screen. The “Select Relay/Alarm” screen will be displayed.
3. Tap the associated/latched alarm field.
4. Tap the “Latching” field.
5. Tap the “Disable” field.
6. Tap the **ACCEPT** button.
7. Tap the **BACK** button.
8. Repeat Steps 3 through 7 to turn latching back on for the selected alarm.

5. Testing Relays and Alarms

The relay/alarm Test feature allows you to verify connection and function by energizing or de-energizing the relay/alarm without having to change the set point(s).

To test a relay or alarm from any “Detailed Operating Screen”:

1. Tap the **ADJUST** button to enter EDIT Mode.
2. Tap the **RELAY** button on the top right side of the screen.
3. Tap the relay or alarm you wish to test.
4. Tap the box to the right of the “Test” field that says **“Disabled”**.
 - a. The text will change to **“Energized”**.
 - b. The relay/alarm will be energized/triggered.

To end the relay/alarm test:

1. Tap the box to the right of the “Test” field that says **“Energized”**.
 - a. The text will change to **“De-energized”**.
 - b. The relay/alarm will be de-energized.
2. Tap the box to the right of the “Test” field that says **“De-energized”**.
 - a. The text will change to **“Disabled”**.
 - b. The relay/alarm will return to its previous status.

NOTE: Exiting the selected relay/alarm set up screen will also exit the test function, returning the relay/alarm to its normal operating mode.

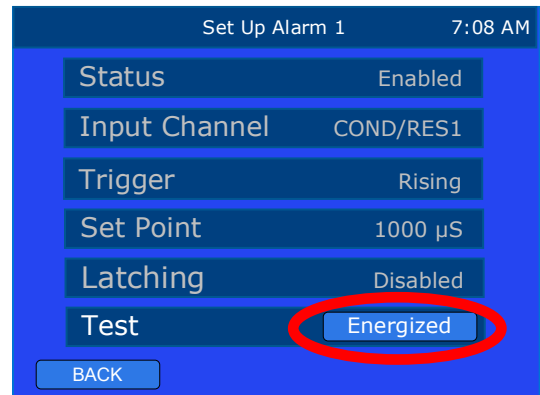
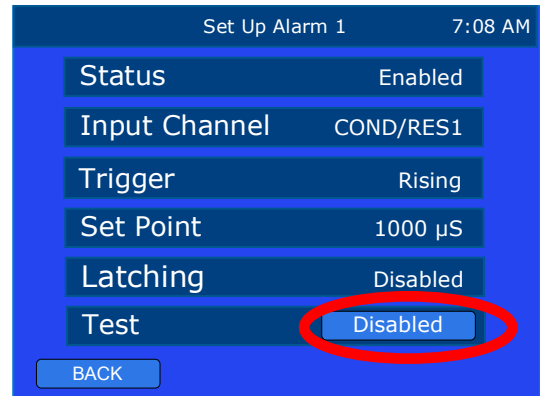

6. Relay/Alarm OVERRIDE Mode

The OVERRIDE feature will cause the system to ignore the trigger status of selected relays/alarms, preventing the selected relays from switching or alarms from sounding off until OVERRIDE is turned off.

1. To OVERRIDE relays/alarms from the “Detailed Operating Screen”:
 - a. Tap the **ADJUST** button to enter EDIT Mode.
 - b. Tap the **RELAY** button on the top right side of the screen.
 - c. Tap the **OVERRIDE** button on the bottom center of the screen.
 - The display will go to the “Override Relays/Alarms” screen. All enabled relays/alarms will be indicated by white text.
 - d. Tap the box to the left of each relay/alarm you wish to override.
 - Green box indicates selected for override.
 - Blue box indicates not selected.
 - e. When you have selected the desired relay(s)/alarm(s), tap the **ACCEPT** button.
 - f. The **OVERRIDE** button will turn red and the selected relay(s)/alarm(s) will go into OVERRIDE mode.
 - g. Tap the **BACK** button to exit relay/alarm settings screen.

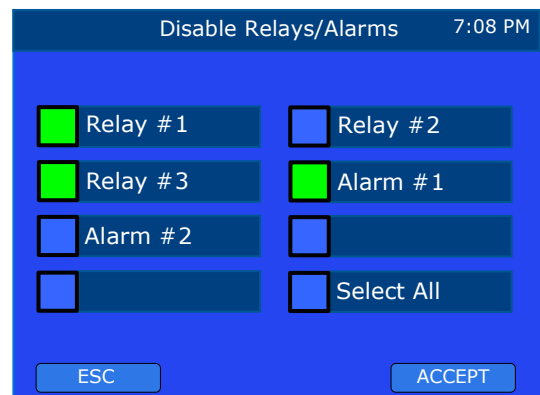
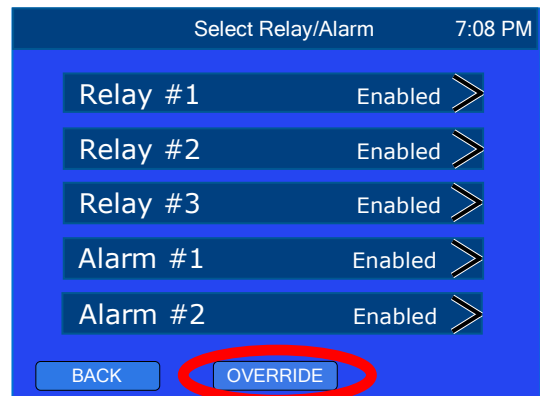

2. To turn OVERRIDE mode off from the “Detailed Operating Screen”:

- a. Tap the **ADJUST** button to enter EDIT Mode.
- b. Tap the **RELAY** button on the top right side of the screen.
- c. Tap the red **OVERRIDE** button on the bottom center of the screen.
The display will acknowledge the override is disabled.
- d. Tap the **BACK** button. The display will return to the “Select Relay/Alarm” screen, the **OVERRIDE** button will be blue, and all relays/alarms will return to their previous state.

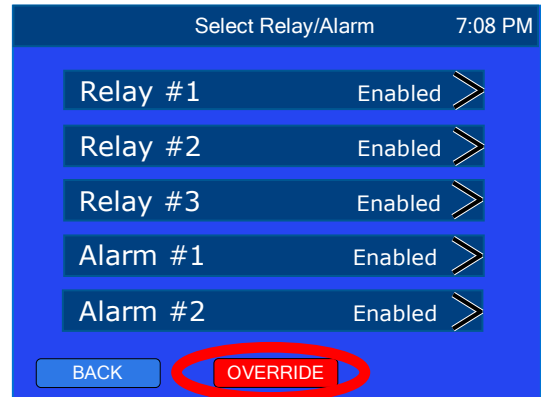

NOTE: If an alarm has been triggered and was set to latch, overriding the alarm will reset the alarm latch.

NOTE: While relays/alarms are in override mode, they will not be activated, but the normal operating screen will still show them as associated with the linked input channels. There will be no indicator on this screen that they are in override mode and the icon background will be blue.

7. Relay/Alarm Settings Reset

The Reset feature will disable the selected relay/alarm and return its settings back to default.

To reset a relay/alarm:

1. From the “Detailed Operating Screen”, tap the **ADJUST** button to enter EDIT Mode.
2. Tap the **RELAY** button on the top right side of the screen.
3. Tap the desired relay/alarm field.
4. Tap the **RESET** button.
5. Tap the **BACK** button to return to the “Select Relay/Alarm” screen.

8. Relay/Alarm Visual Indicators

a) Relay/Alarm Icons

When a relay and/or alarm is set up and linked to an input channel, the corresponding relay/alarm icon (R1, R2, R3, A1, or A2) will show up on the Operating Screen for the associated input channel regardless of its status (enabled/disabled). If you want to stop a disabled relay/alarm icon from showing up on an input channel, simply reset the relay/alarm, see Line 7: “Relay/Alarm Settings Reset”, above.

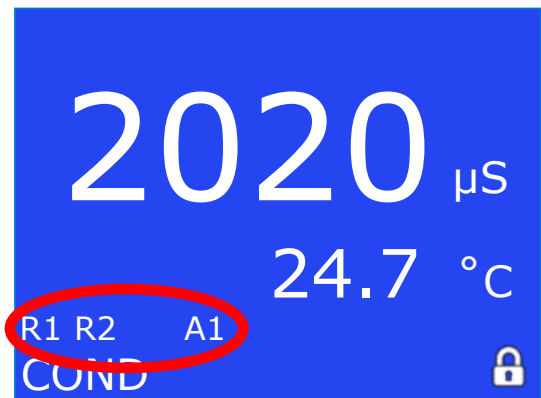

b) Relay/Alarm Color Indicators

During normal operating mode each input channel’s background color and the relay/alarm icon colors change depending on relay/alarm status; blue indicates the measurement is within normal operating range, yellow indicates the measurement value is within warning range, and red indicates the measurement value has reached or gone beyond the set point.

The color of the LED on the front bezel indicates the status of the system; blue when all measurements are within normal operating range, yellow if no relay or alarm is triggered, but at least one is within warning range, and red if any relay or alarm is triggered.

In the Normal Operating Screen Example 1:

- Relay 1 is disabled, but still linked to this input channel.
- Relay 2 is enabled, linked to this input channel, and within normal operating range.
- Relay 3 is enabled, linked to this input channel, and within warning range.
- Alarm 1 is enabled, linked to this input channel, and the measurement value is beyond the set point.
- Alarm 2 is not linked to this input channel (so it is not displayed).

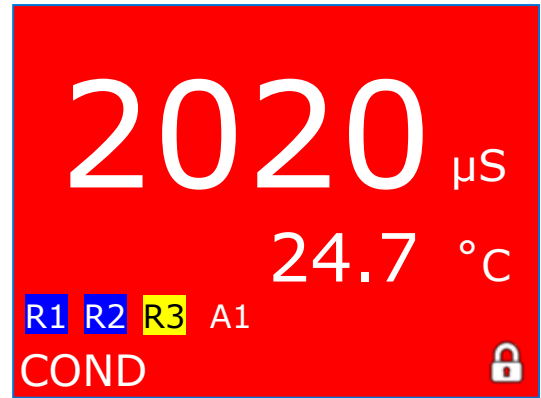

Normal Operating Screen Example 1

In the Normal Operating Screen Example 2:

- Relay 1 is disabled, but still linked to this input channel.
- Relay 2 is enabled, linked to this input channel, and within normal operating range.
- Relay 3 is enabled, linked to this input channel, and within warning range.
- Alarm 1 is enabled, linked to this input channel, and within normal operating range.
- Alarm 2 is not linked to this input channel (so it is not displayed).

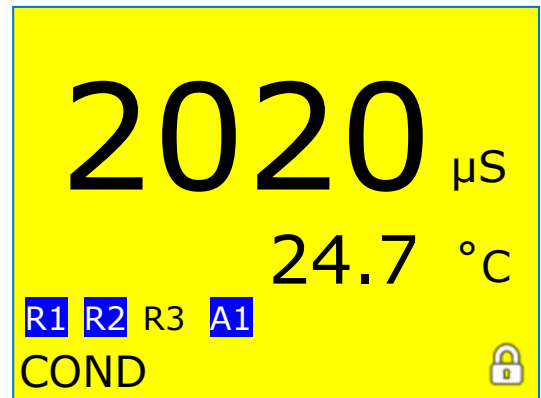

Normal Operating Screen Example 2

While in the “Detailed Operating Screen” the screen background color will be blue, the relay/alarm icon colors will indicate their status, and the color of the LED on the front bezel indicates the status of the system.

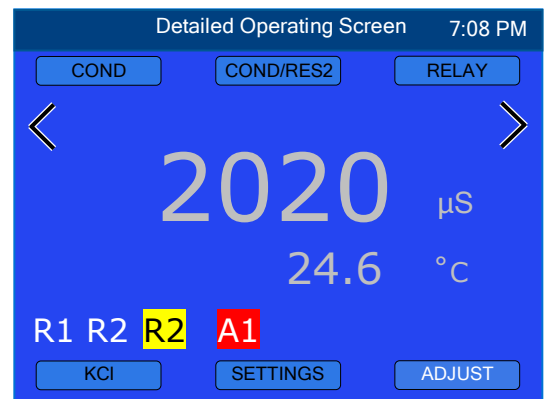

Detailed Operating Screen

NOTE: While relays/alarms are in override mode, they will not be triggered, but the normal operating screen will still show them as associated with the linked input channel. There will be no indication on this screen that they are in override mode. The screen, LED, and relay/alarm icon background will be blue.

VIII. DETAILED SYSTEM SETTINGS

The System Settings are very similar to the Initial Setup, but instead of prompting you through each setting, you are able to select which setting(s) you wish to set up/adjust. In this section we will describe how to change any of the settings programmed during the initial setup. There are also additional features/settings available for the system, for example resetting passwords or changing operator access.

A. Date and Time

To set or edit the date and time from the “Detailed Operating Screen”:

1. Tap the **ADJUST** button to enter EDIT Mode.
2. Tap the **SETTINGS** button.
3. Tap the “System” field.
4. Tap the “Date/Time” field.
5. Tap the date field.
 - a. Tap the date format you prefer; MM/DD/YYYY, DD/MM/YYYY or YYYY/MM/DD.
 - b. Tap the **NEXT** button. The display will go to the “Adjust Date” screen.
 - c. Using the up and down arrows, set the correct day, month, and year.
 - d. Tap the **ACCEPT** button. The display will return to the “Set Up Date and Time” screen.
6. Tap the time field.
 - a. Tap the time format you prefer; “12 Hour” or “24 Hour”.
 - b. Tap the **NEXT** button. The display will go to the “Set Up Time” screen.
 - c. Using the up and down arrows, set the correct time.
 - d. Tap the **ACCEPT** button. The display will return to the “Set Up Date And Time” screen.
7. When you are satisfied with the date and time settings tap the **BACK** button to return to the System Settings screen.

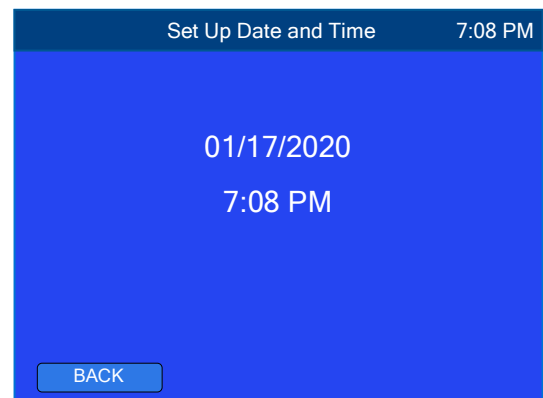
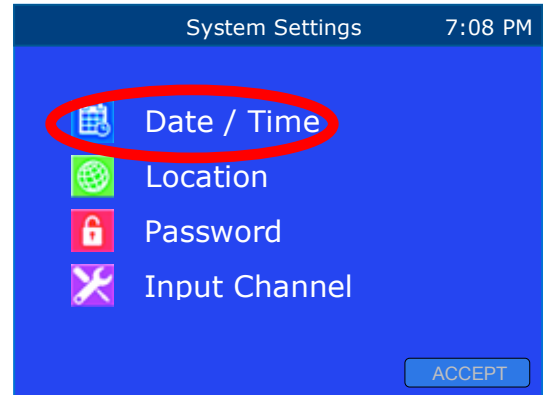

B. Location

To enter/edit location information from the “Detailed Operating Screen”:

1. Tap the **ADJUST** button to enter EDIT Mode.
2. Tap the **SETTINGS** button.
3. Tap the “System” field.
4. Tap the “Location” field.
5. Tap the box to the right of each field you wish to enter/edit. An alphanumeric keypad will be displayed.
6. Enter the desired data (up to 9 characters per field) then tap “OK”.
7. When you are satisfied with the Location Info, tap the **BACK** button to return to the System Settings screen.



C. Passwords and Security

The password feature allows you to set password protection for different levels of access. Once the administrator password is set up, the administrator will be able to limit the access of operators to prevent unauthorized changes in settings / configuration.

NOTE: If the administrator password is not set up, anyone will have access to all settings/configuration.

1. Administrator Password Setup

If the Security Password feature was skipped during the Initial Setup, it can be set up or changed here.



Once the administrator password is set, it may only be reset using that password or by contacting the Myron L® Company.

Make sure the Administrator’s password is recorded in a secured location. If this password is lost the instrument CANNOT be reprogrammed without contacting the Myron L® Company.

To set up the Administrator Password from any “Detailed Operating Screen”:

1. Tap the **ADJUST** button to enter EDIT Mode.
2. Tap the **SETTINGS** button.
3. Tap the “System” field.
4. Tap the “Password” field.
5. Tap the “Administrator” field.
6. Tap the “Setup Password” field.
7. Tap the “New Password” field. An alphanumeric keypad will be displayed.
8. Enter the Administrator Password (up to 8 characters) then tap “OK”.
9. Tap the “Confirm Password” field.
10. Re-enter the Administrator password then tap “OK”.
11. Tap the **ACCEPT** button. The display will return to the “Set Up Security” screen.
12. Continue with additional password settings or tap the **BACK** button 2 times to return to System Settings.

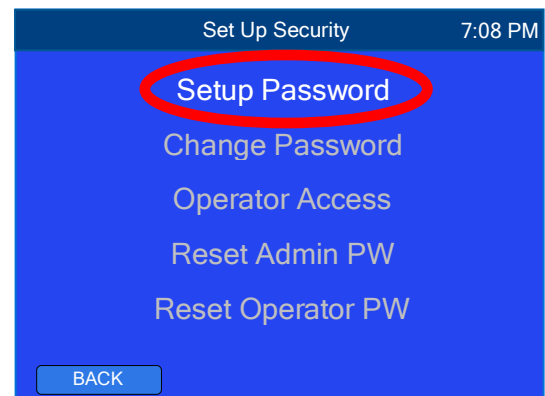
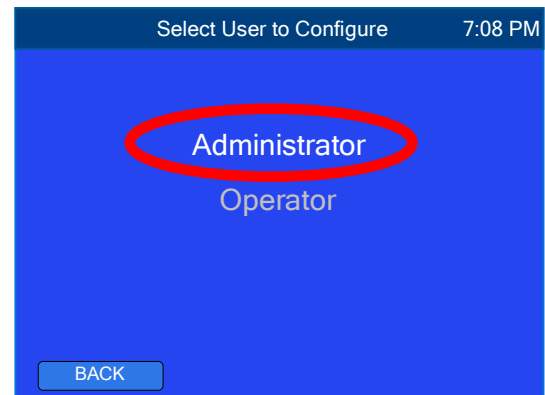
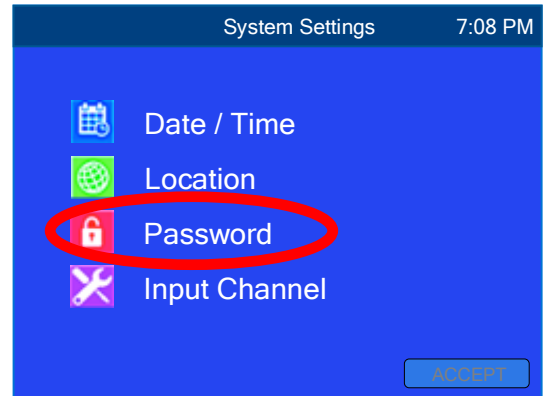

2. Operator Access Setup

Once the Administrator’s password has been set up, you will be able to configure Operator Access.

NOTE: If Operator Password is NOT set up, only the administrator will have access to the 900’s settings.

The Administrator may limit the access of Operators to any or all of the following areas:

- **View Settings**
 - Allows Operator to view all settings
- **Measurement**
 - Calibration
 - Measurement Type
 - Sensor Model and Settings
 - Solution Type (for Conductivity, TDS, Resistivity or Salinity inputs)
 - Temperature Unit
- **Relay / Alarm**
 - Status
 - Trigger Type
 - Set Point
 - Alarm Latching
 - Test
 - Override
- **System Settings**
 - Date/Time
 - Location
 - Display Setting
 - Input Channel (Enable/disable)
- **Adv. Settings**
 - Output
 - 4-20mA Output
 - 0-10V Output
 - Derived Measurement
 - % Rejection

To set up operator access from any “Detailed Operating Screen”:

1. Tap the **ADJUST** button to enter EDIT Mode.
2. Tap the **SETTINGS** button.
3. Tap the “System” field.
4. Tap the “Password” field.
5. Tap the “Administrator” field.
6. Tap the “Operator Access” field.
7. Tap the box to the left of each function you want operators to access.
 - a. Green box allows access
 - b. Blue box denies access
8. When you are satisfied with selections, tap the **ACCEPT** button. The display will return to the “Set Up Security” screen.

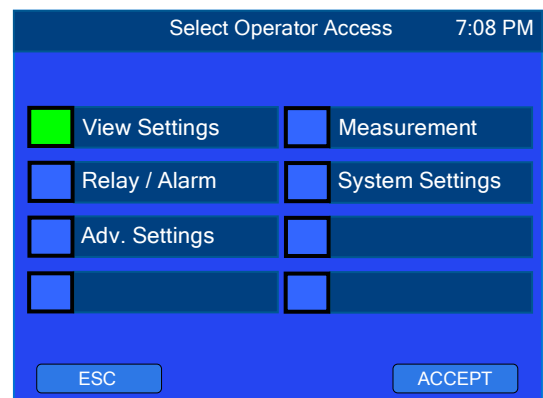

3. Operator Password Setup

To set up the operator password from any “Detailed Operating Screen”:

1. Tap the **ADJUST** button to enter EDIT Mode.
2. Tap the **SETTINGS** button.
3. Tap the “System” field.
4. Tap the “Password” field.
5. Tap the “Operator” field.
6. Tap the “Setup Password” field.
7. Tap the “New Password” field. A numeric keypad will be displayed.
8. Enter the operator password (up to 8 digits) then tap “OK”.
9. Tap the “Confirm Password” field.
10. Re-enter the operator password and tap “OK”.
11. Tap the **ACCEPT** button. The display will return to the “Set Up Security” screen.

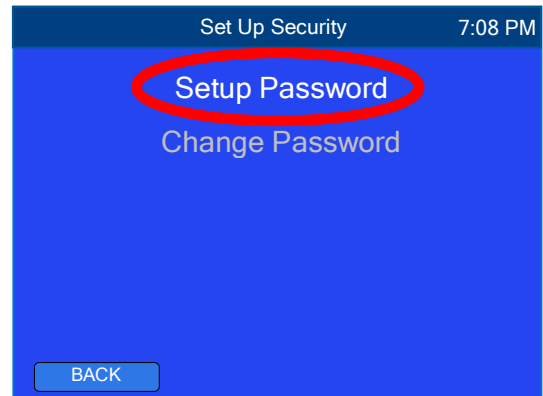

4. Change Administrator Password

To change the administrator password from the “Detailed Operating Screen”:

1. Tap the **ADJUST** button to enter EDIT Mode.
2. Tap the **SETTINGS** button.
3. Tap the “System” field.
4. Tap the “Password” field.
5. Tap the “Administrator” field.
6. Tap the “Change Password” field.
7. Tap the “Old Password” field.
8. Enter current administrator password then tap “OK”.
9. Tap the “New Password” field.
10. Enter the new password (up to 8 characters) then tap “OK”.
11. Tap the “Confirm Password” field.
12. Re-enter the new password then tap “OK”.
13. Tap the **ACCEPT** button. The display will return to the “Set Up Security” screen.

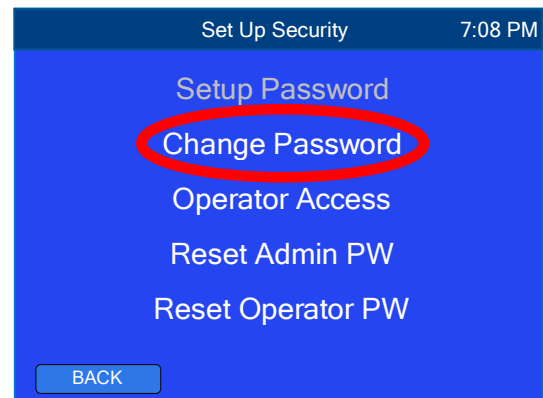

5. Change Operator Password

To change the operator password from the “Detailed Operating Screen”:

1. Tap the **ADJUST** button to enter EDIT Mode.
2. Tap the **SETTINGS** button.
3. Tap the “System” field.
4. Tap the “Password” field.
5. Tap the “Operator” field.
6. Tap the “Change Password” field.
7. Tap the “Old Password” field.
8. Enter current operator password then tap “OK”.
9. Tap the “New Password” field.
10. Enter the new operator password (up to 8 digits) then tap “OK”.
11. Tap the “Confirm Password” field.
12. Re-enter the new password then tap “OK”.
13. Tap the **ACCEPT** button. The display will return to the “Set Up Security” screen.

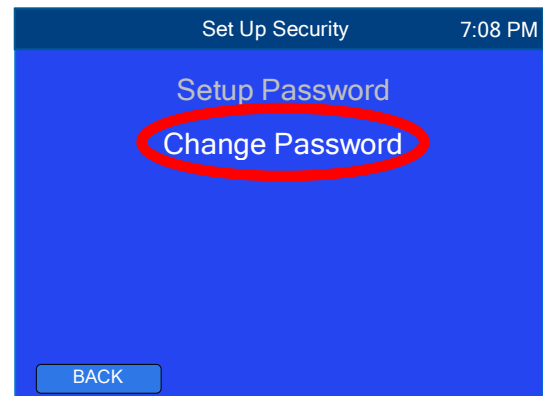

6. Reset Administrator Password

Resetting the administrator password will eliminate the password protection of the 900. Everyone will have access to ALL settings until another administrator password has been set up.

To reset the administrator password from the “Detailed Operating Screen”:

1. Tap the **ADJUST** button to enter EDIT Mode.
2. Tap the **SETTINGS** button.
3. Tap the “System” field.
4. Tap the “Password” field.
5. Tap the “Administrator” field.
6. Tap the “Reset Admin PW” field.
7. Enter the current administrator’s password then tap “OK”. The Administrator Password will be reset.

NOTE: Resetting the administrator password automatically resets the operator password.

NOTE: If the administrator has forgotten their password, it may only be reset by a 900 Series Technician. Contact the Myron L® Company.

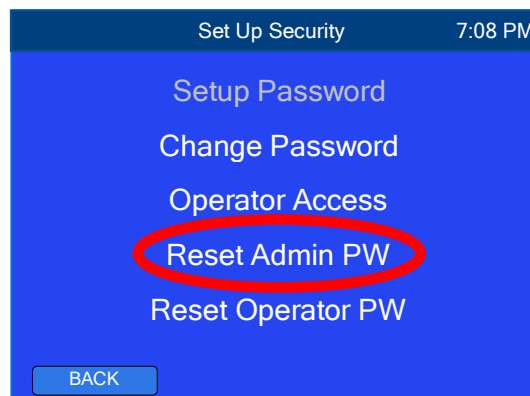

7. Reset Operator Password

Resetting the operator password will erase it, preventing any access without the administrator’s password until another operator password has been set up.

To reset the Operator Password from any “Detailed Operating Screen”:

1. Tap the **ADJUST** button to enter EDIT Mode.
2. Tap the **SETTINGS** button.
3. Tap the “System” field.
4. Tap the “Password” field.
5. Tap the “Administrator” field.
6. Tap the “Reset Operator PW” field.
7. Enter the Administrator password then tap “OK”. The 900 will reset the Operator Password and return to the Set Up Security screen.

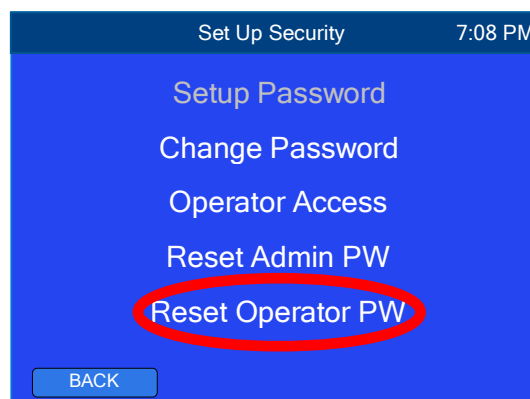

D. Input Channels

1. Enable/Disable Input Channels

Each connected sensor/input must be enabled prior to operation. This is done from the “Select Input Channel” screen. To enable or disable input channels from any “Detailed Operating Screen”:

1. Tap the **ADJUST** button to enter EDIT Mode.
2. Tap the **SETTINGS** button.
3. Tap the “System” field.
4. Tap the “Input Channel” field. The display will go to the “Select Input Channel” screen.
5. Tap the box to the left of each input channel you wish to enable or disable.
 - Green box indicates the input channel is enabled.
 - Blue box indicates the input channel is disabled.
6. When you are satisfied with the status of each input channel, tap the **ACCEPT** button. The display will go to the “Select Screen Layout” screen.
7. Select the screen layout you prefer then tap the **ACCEPT** button.

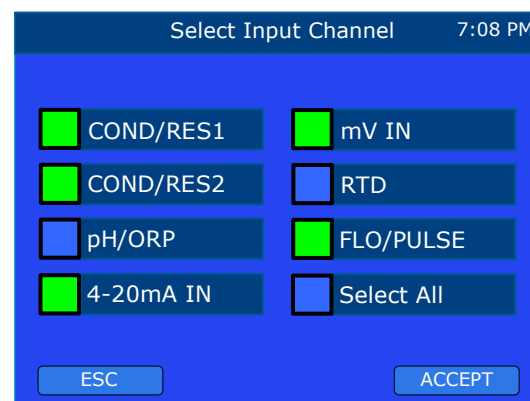

IX. DISPLAY SETTINGS

The Display Settings feature allows the user to customize the 900's display to best fit their application. From the "Set Up Display Settings" screen you may select/adjust the following settings:

- **Screen Layout:** Select the number of input channels you want displayed during normal operating mode.
- **Brightness:** Adjust the brightness of the display.
- **Night Mode:** Dims the LCD during times when no one will be available to view the screen.
- **Timeout:** Allows the user to program the instrument to exit setting screens and return to normal measurement mode after a user specified time of inactivity. Unsaved settings will be deleted.

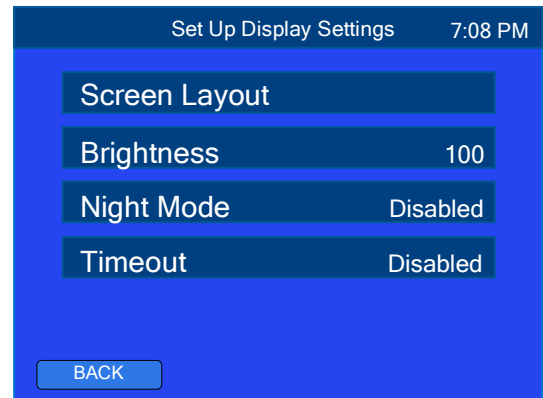

1. Screen Layout

Screen Layout allows you to select the screen layout for normal operating mode. You may select one of the following:

- All Channels: This feature allows you to view all inputs with their current readings, and outputs with their status.
- Single Channel: One input channel is displayed at a time.
 - When screen is UNLOCKED the display will alternate between all active input channels.
 - When the screen is LOCKED the display will remain on the selected input channel.
- Dual Channel: Two input channels are displayed on the screen.
- Triple Channel: Three input channels are displayed on the screen.
- Quadruple Channel: Four input channels are displayed on the screen.

See the next page for examples of each screen layout.

To change the **Screen Layout** from the "Detailed Operating Screen":

1. Tap the **ADJUST** button to enter EDIT Mode.
2. Tap the **SETTINGS** button.
3. Tap the "Display" field.
4. Tap the "Screen Layout" field.
5. Tap the screen layout you prefer; the selection will be indicated by white text.
6. Tap the **ACCEPT** button.

Example of Operating Screens:

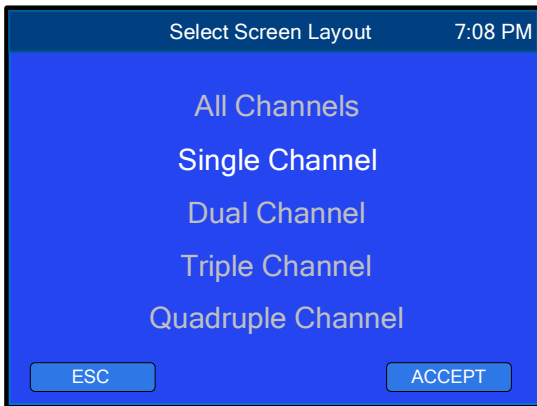

“Select Screen Layout” menu

Inputs		Outputs	
COND/RES1	1957 μ S	0-10V	7.87 V
COND/RES2	2020 μ S	4-20mA	4.00mA
pH/ORP	7.16	Relay 1	Enabled
mV IN	442 mV	Relay 2	Enabled
RTD	23.2 $^{\circ}$ C	Relay 3	Enabled
4-20mA IN	13.45 mA	Alarm 1	Enabled
FLO/PULSE	1.45 gps	Alarm 2	Disabled

“All Channels” Screen Layout



“Single Channel” Screen Layout



“Dual Channel” Screen Layout



“Triple Channel” Screen Layout

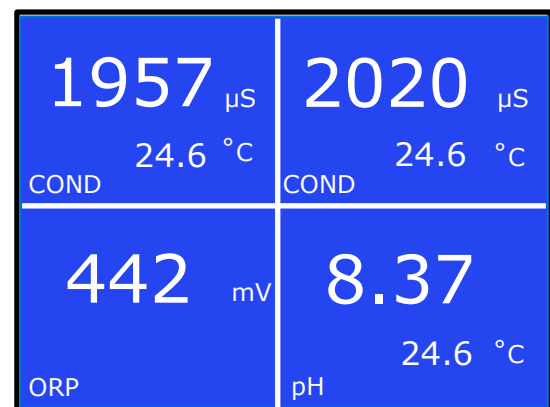

“Quadruple Channel” Screen Layout

2. All Channels Screen Layout



The All Channels screen layout allows you to view all inputs with their current readings, as well as outputs with their status. This screen allows quick access to many different areas:

- Tapping an input field will bring you to the associated “Detailed Operating Screen”.
- Tapping an output field (including relays and alarms) will bring you to the associated setup screen.
- Tapping a disabled input channel (text is gray) will bring you to the Select Input Channel screen (where you can enable/disable any or all input channels).

3. Locking/Unlocking the Single Channel Screen

The default mode for Single Channel screen layout is unlocked (the screen alternates between all enabled input channels).

To lock/unlock the Single Channel screen from normal Operating mode simply tap the lock icon on the lower right side of the screen. The lock will switch between locked and unlocked each time you tap it.

-  Indicates the screen is unlocked (the screen will alternate between enabled input channels)
-  Indicates the screen is locked (the selected input channel will remain on the screen).

To change the input channel displayed on a locked screen, see Screen Configuration, below.



4. Screen Configuration

The screen configuration feature allows the you to rearrange measurements on the display to best fit your needs. Not to be confused with the “Screen Layout” which allows the user to select HOW MANY measurement parameters are displayed on the screen, the screen configuration feature allows the user to select WHERE ON THE SCREEN each reading is displayed. Screen configuration is changed through the normal operating screen.

To change the Screen Configuration:

1. Tap the location on the operating screen you wish to configure. The display will go to the “Detailed Operating Screen”.
2. Tap the **ADJUST** button to enter EDIT Mode.
3. Using the left and right arrows, select the input channel you wish displayed in that location.
4. Tap the **ADJUST** button to exit EDIT Mode.
5. Tap the gray measurement value to return to the “Operating” screen.
6. Repeat Steps 1 through 5 above to configure each location on the screen.

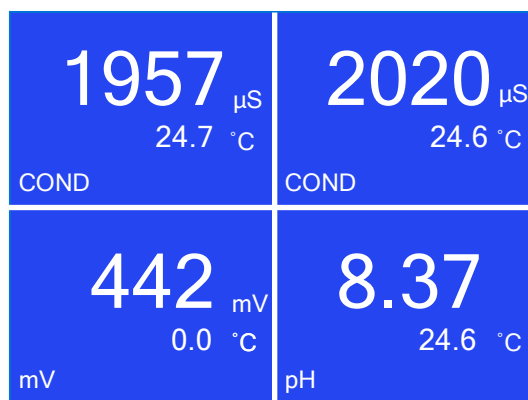

NOTE: Any changes to the Input Channel activations will cause the screen configuration to reset.

NOTE: The “All Channels” screen layout has a fixed configuration and is not configurable.

5. Brightness

The display brightness feature allows you to adjust the display's brightness for optimal viewing depending on location/lighting.

To adjust the display's brightness from the "Detailed Operating Screen":

1. Tap the **ADJUST** button to enter EDIT Mode.
2. Tap the **SETTINGS** button.
3. Tap the "Display" field.
4. Tap the "Brightness" field. The "Set Up Display Brightness" screen will be displayed with a slide bar and a number indicating the current brightness.
5. Move the slide bar left or right to adjust the brightness.
6. Tap the **ACCEPT** button.

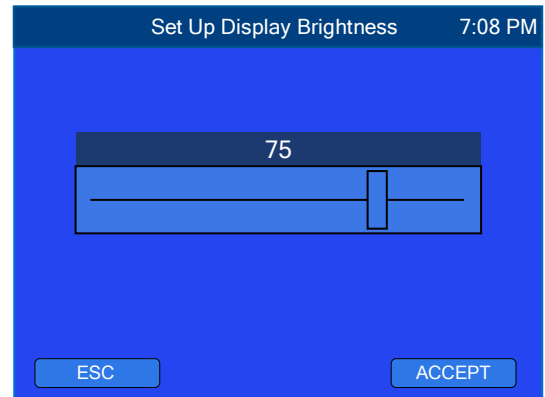

6. Night Mode

The Night Mode settings allow you to program the display to dim during specific time periods. All functions continue to operate normally while the display is dimmed due to Night Mode settings.

To set up Night Mode from the "Detailed Operating Screen":

1. Tap the **ADJUST** button to enter EDIT Mode.
2. Tap the **SETTINGS** button.
3. Tap the "Display" field.
4. Tap the "Night Mode" field.
5. Tap the "Status" field.
 - a. If **Disable** was selected, tap the **ACCEPT** button. The screen will return to the "Set Up Night Mode" screen. Tap the **BACK** button to exit Night Mode settings.

-or-

 - b. If **Enable** was selected, tap the **NEXT** button. The display will prompt you through the rest of the Night Mode settings. Continue to Step 7.
7. Set the Turn On Time:
 - a. Using the up/down arrows, set the time for Night Mode to start.
 - b. Tap the **ACCEPT** button.
8. Set the Turn Off Time:
 - a. Using the up/down arrows, set the time for Night Mode to stop.
 - b. Tap the **ACCEPT** button.
9. Set the Display Brightness for Night Mode:
 - a. Using the slide bar, adjust the brightness level you want while Night Mode is on.
 - b. Tap the **ACCEPT** button.
10. Night Mode settings are now complete. Tap the **BACK** button to exit Night Mode settings.



7. Timeout Settings

The Timeout Settings allow you to program the 900 to exit the “Detailed Operating Screen” (or any other settings screen) and return to normal measurement mode after a user specified time of inactivity. When this happens, only ACCEPTED settings will be saved.

To set up the Timeout feature from the “Detailed Operating Screen”:

1. Tap the **ADJUST** button to enter EDIT Mode.
 2. Tap the **SETTINGS** button.
 3. Tap the “Display” field.
 4. Tap the “Timeout” field.
 5. Tap the “Status” field.
 6. Tap the desired status.
 - a. If **Disable** was selected, tap the **ACCEPT** button. The screen will return to the “Timeout Settings” screen. Tap the **BACK** button to exit Timeout settings.
 - or-
 - b. If **Enable** was selected, tap the **NEXT** button. The display will prompt you through the rest of the Timeout settings. Continue to Step 7.
7. Set Timeout Time:
- a. Using the up/down arrows, adjust the amount of time of inactivity before the Timeout feature returns the 900 to normal operating mode. The Timeout range is from 15 seconds to 10 minutes.
 - b. Tap the **ACCEPT** button.
8. Timeout settings are now complete. Tap the **BACK** button to exit Timeout settings.



X. ADVANCED SETTINGS

A. 0-10V Recorder Output

The 900 Series 0-10V Recorder Output can be programmed to output 0-10 or 0-5 VDC and export signals from any input channel or derived % Rejection value to a remote meter, recorder, PLC, or SCADA system.

1. Programming the 0-10V Recorder Output

To set up the 0-10V Recorder Output from the “Detailed Operating Screen”:

1. Tap the **ADJUST** button to enter EDIT Mode.
2. Tap the **SETTINGS** button.
3. Tap the “Advanced” field.
4. Tap the “Output” field.
5. Tap the “0-10 V” field.
6. Enable/Disable the 0-10V Output:
 - a. Tap the “Status” field.
 - b. Tap the desired status (Enable/Disable).
 - i. If **Disable** was selected, tap the **ACCEPT** button, the display will return to the “Set Up 0-10V Output” screen. Tap the **BACK** button to exit 0-10 V output settings.
-or-
 - ii. If **Enable** was selected, tap the **NEXT** button, the 900 will prompt you through the necessary setup. Continue to Line 7.
7. Select the source input:
 - a. Using the up/down arrows, select the desired source input.
 - b. Tap the **NEXT** button.
8. Set the measurement range:

NOTE: To switch between positive and negative values, tap the “±” symbol.

NOTE: An error screen will appear if you attempt to enter set points values beyond specified limits.

 - a. Tap the “Full Scale” field.
 - b. Enter the full scale value (to be output as 5V or 10V).
 - c. Tap “Enter”.
 - d. Tap the “Zero Scale” field.
 - e. Enter the low measurement value (to be output as 0V).
 - f. Tap “Enter”.
 - g. Tap the **NEXT** button.
9. Set the output voltage range:
 - a. Tap on the desired output voltage (0-10V or 0-5V).
 - b. Tap the **ACCEPT** button.
10. The 0-10V Output settings are complete. Tap the **BACK** button to exit.

NOTE: Once the 0-10V output has been programmed, the real-time voltage output will be displayed on the “Select Output To Configure” screen, on the right side of the 0-10V field.

NOTE: All relay(s)/alarm(s) and/or output signals associated with an input channel will be disabled if the measurement type for that input channel is changed or the input channel is disabled.

NOTE: For calibration procedures, see “0-10 VDC Recorder Output Calibration” on page 83.

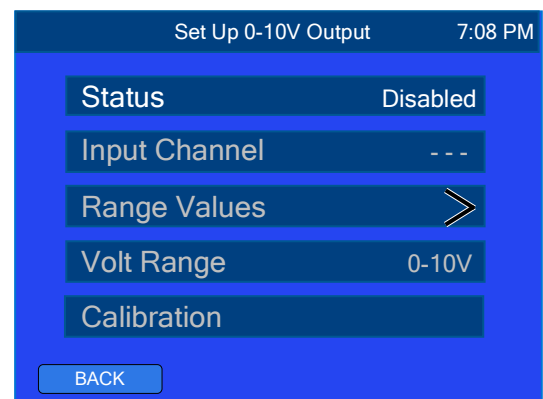
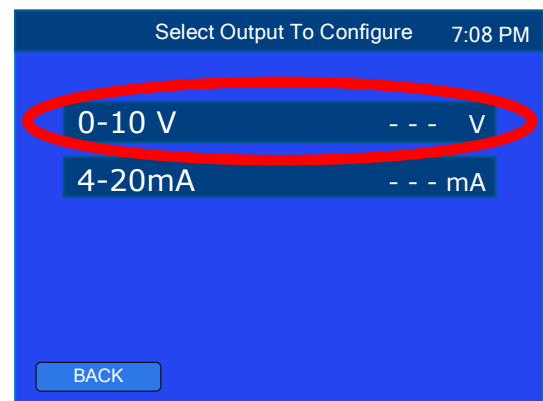
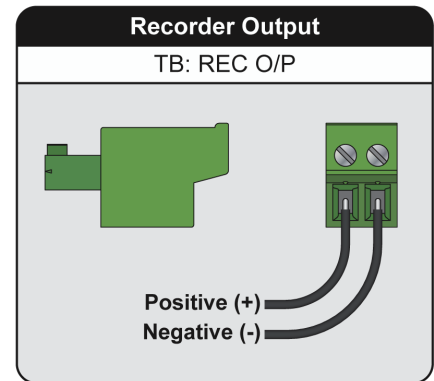

2. Voltage Divider

A voltage divider gives the user the ability to scale or tailor the output to a particular need or requirement due to the input of another device, i.e. the output of the 900 is 0-5V or 0-10V while the input requirement of a particular recording device is 0-1V.

To install a voltage divider:

1. Program the 900 for 0-10V output.
2. Install two resistors across the 0-10V output.
3. Recalibrate to required voltage.

Example, for a 0-1V output:

Resistor “A” is 9K and resistor “B” is 1K

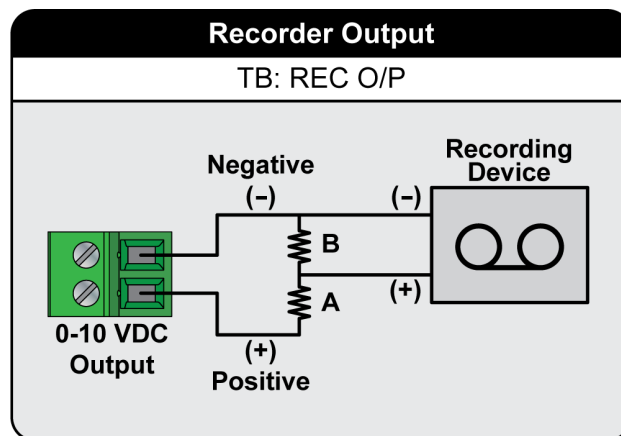

B. 4-20mA / 0-20mA Output (Model 900M-3C only)

The 4-20mA / 0-20mA output gives the user the ability to send a signal a long distance with minimal interference and signal degradation. The output is an isolated 4-20mA / 0-20mA signal that corresponds to a user programmable range. This output is easily configured to be either self-powered (powered by the 900) or remote-powered (loop powered) as required for your particular application.

NOTE: The maximum impedance of current loop should not exceed 600 Ω .

Since the output is an isolated current loop, it is the ideal choice for applications requiring; a control signal to be run for longer distances, systems requiring a 4-20 mA (or 0-20 mA) input or in instances where isolation is necessary.

The 0/4-20mA output will not be degraded in accuracy even when the ground differences are as much as 120VAC @ 60Hz. Interface wire resistance of up to 350 Ω will not degrade the accuracy of the output when interfaced to a typical 250 Ω input impedance of a transmitter current input device.

There are two modes in which current loop transmitters operate:

1. Self-Powered – the 900 Series monitor provides the power to drive the 0/4-20mA current.
2. Remote-Powered – the receiving instrument provides the power to drive the 0/4-20mA current.

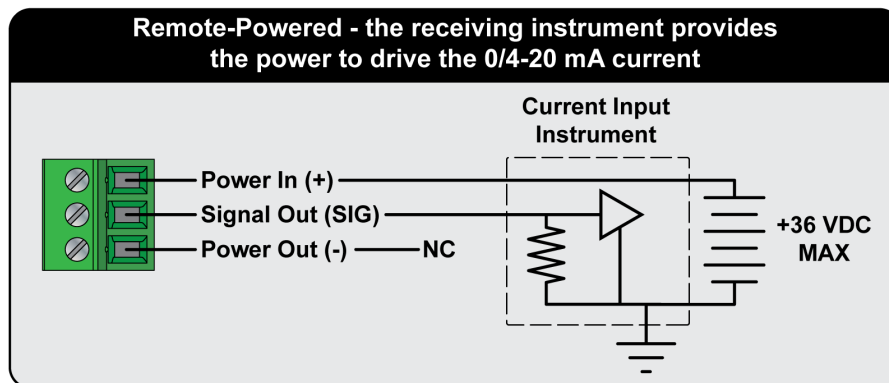
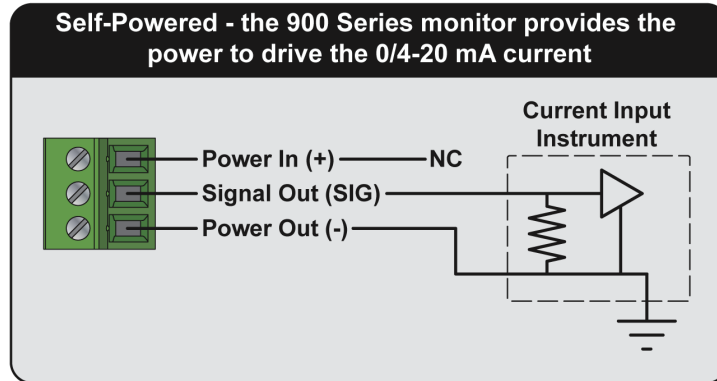

To set up the 0/4-20mA output from any “Detailed Operating Screen”:

1. Tap the **ADJUST** button to enter EDIT Mode.
2. Tap the **SETTINGS** button.
3. Tap the “Advanced” field.
4. Tap the “Output” field.
5. Tap the “4-20mA” field.
6. Select the status:
 - a. Tap the ‘Status’ field.
 - b. Tap the desired status:
 - i. If **Disable** was selected, tap the **ACCEPT** button, the display will return to the “Set Up 4-20mA Output” screen.
 - or-
 - ii. If **Enable** was selected, tap the **NEXT** button, the 900 will prompt you through the necessary setup. Continue to Step 7.
7. Select the input channel you want to associate with the 4-20mA Output:
 - a. Using the up/down arrows, select the desired input.
 - b. Tap the **NEXT** button.
8. Set up the 4-20mA Range:
 - a. Set full scale measurement value:
 - i. Tap the “Full Scale” field.
 - ii. Enter the full scale value (the measurement value to be output as 20mA).
 - iii. Tap “Enter”.
 - b. Set zero scale value:
 - i. Tap the “Zero Scale” field.

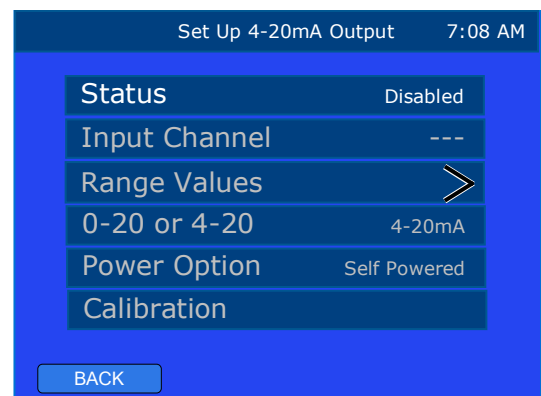
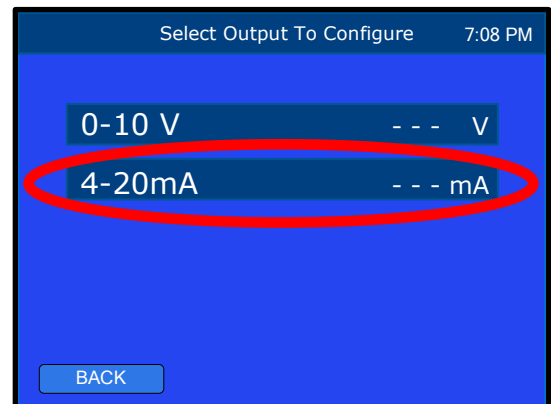

- ii. Enter the zero scale value (the measurement value to be output as 0 or 4mA).
- iii. Tap “Enter”.
- c. Tap the **NEXT** button.
- 9. Select the Output Range:
 - a. Tap the desired output current (4-20mA/0-20mA).
 - b. Tap the **NEXT** button.
- 10. Select the Power Option:
 - a. Tap the desired power option (Self Power or Remote Power).
 - b. Tap the **ACCEPT** button.
- 11. The 4-20mA Output settings are complete.
- 12. Tap the **BACK** button to exit.

NOTE: To disable the 4-20mA output simply follow Steps 1 through 6, select “Disable” then tap the **ACCEPT** button.

NOTE: Once the 4-20mA output has been programmed, the real-time output value will be displayed on the “Select Output To Configure” screen, on the right side of the 0/4-20mA field.

NOTE: All relay(s)/alarm(s) and/or output signals associated with an input channel will be disabled if the measurement type for that input channel is changed or the input channel is disabled.

NOTE: For calibration procedures, see “4-20 mA Output Calibration” on page 82.

C. Derived Measurement

1. Percent (%) Rejection

Percent Rejection measurement is designed to help quantify the effectiveness of water filtration systems. This is accomplished by comparing the feed water to the permeate (product) water to determine the percent of dissolved solids removed or rejected by the filtration system. The formula to calculate the percent rejection is:

$$\text{Percent Rejection} = \frac{\text{Feed Water} - \text{Permeate}}{\text{Feed Water}} \times 100$$

Example: Feed Water = 1000 ppm and Permeate = 150 ppm
 1000 – 150 = 850
 850 / 1000 = 0.85
 0.85 x 100 = 85% Rejection

Settings Required Prior to Enabling % Rejection:

- COND/RES1 and COND/RES2 input channels must be enabled.
- COND/RES1 and COND/RES2 must be set to the same measurement type (example: TDS).
- COND/RES1 sensor installed in the feed water line.
- COND/RES2 sensor installed in the permeate line.

To Set up the % Rejection from any “Detailed Operating Screen”:

1. Tap the **ADJUST** button to enter EDIT Mode.
2. Tap the **SETTINGS** button.
3. Tap the “Advanced” field.
4. Tap the “Derived” field.
5. Tap the “% Rejection” field.
6. Tap “Enable” or “Disable” as desired.
7. Tap the **ACCEPT** button.
8. Tap the BACK button 3 times to return to the normal operating screen.

When you enable % Rejection, the screen layout and configuration will auto-format to the % Rejection measurement screen layout: Triple Channel operating screen with % Rejection on top and COND1 and COND2 below. The screen layout and configuration may be reconfigured to best fit your application. See “DISPLAY SETTINGS” on page 57.

NOTES:

- While % Rejection is enabled, you will not be able to disable COND/RES1 or COND/RES2 input channels. You must first disable the % Rejection function.
- If COND/RES1 and COND/RES2 are not set to the same measurement type, the % Rejection value will indicate an error (Err).
- If the COND/RES1 measurement is less than the COND/RES2 measurement the % Rejection value will indicate under range (-UR-). (Reverse that for Resistivity.)

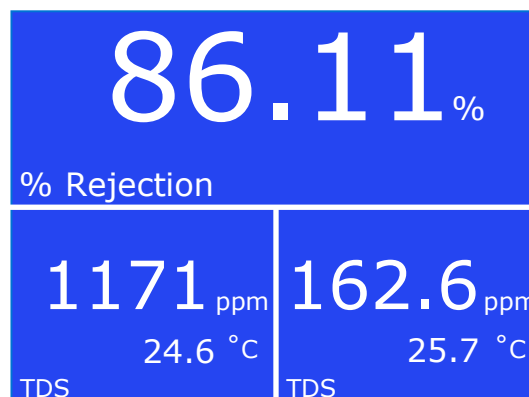
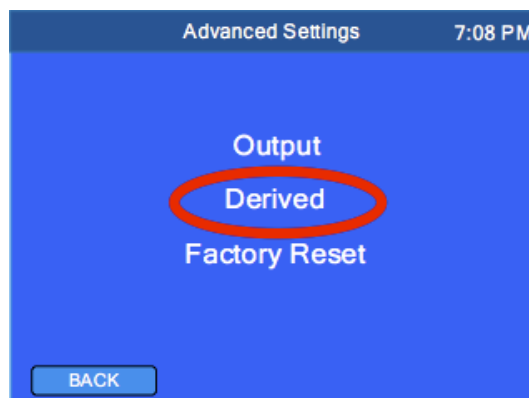

D. User Mode Tempco and Ratio Settings

Input Channels: COND/RES1 and COND/RES2

The User Mode solution type allows you:

- Program a customized temperature compensation factor (from 0 to 10%/°C).
- Disable temperature compensation (0%/°C).
- Program a custom conductivity to TDS Ratio (from 0.20-7.99).

1. Selecting the User Mode Solution Type

To select User Mode solution type from the desired input channel’s “Detailed Operating Screen”:

1. Tap the **ADJUST** button to enter EDIT Mode.
2. Tap the solution type button on the lower left side of the screen.
3. Tap “User”.
4. Tap the **ACCEPT** button. The display will go to the “Enter User Tempco” screen with a numerical keypad. Continue to Section 2: “Disable or Customize Temperature Compensation”, below.

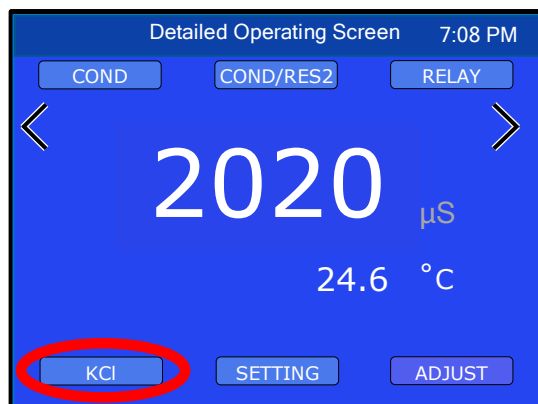

2. Disable or Customize Temperature Compensation

To disable or customize temperature compensation from the “Enter User Tempco” screen:

1. Enter the custom temperature compensation factor (from 0.00 to 10.00%/°C) to be used for this input channel. To disable temperature compensation, enter 0.00.
2. Tap “Enter”.
 - a. If the measurement type is conductivity, resistivity, or salinity, the display will return to the “Detailed Operating Screen”.

-or-
 - b. If the measurement type is TDS, the display will go to the “Enter TDS Ratio” screen with a numerical keypad.
 - Tap “ESC” to exit without adjusting the TDS Ratio and return to the “Detailed Operating Screen”.
 - or-
 - Continue to Line 3: “Enter Custom Conductivity to TDS Ratio”, below.

3. Enter Custom Conductivity to TDS Ratio

To determine the conversion ratio for a custom solution of known TDS ppm value, measure the solution conductivity at 25°C and divide the ppm value by the μS value. For example, a solution of known 75 ppm TDS and measured 100 μS conductivity at 25°C would have a conversion ratio of 75/100 or 0.75.

To enter a custom conductivity to TDS ratio from the “Enter TDS Ratio” screen:

1. Enter the custom TDS ratio (from 0.20 to 7.99) to be used for this input channel.
2. Tap “Enter”. The display will return to the “Detailed Operating Screen”.

NOTES:

- A salinity measurement set to User solution type will utilize the same conductivity to TDS ratio that was set while in TDS mode.
- There is a separate calibration for each of the 4 solution types. Calibration is performed separately for each input channel.

E. Factory Reset

The Factory Reset feature allows you to quickly erase **ALL** the user-programmed settings in the 900 and return the unit to a known state (just as it was when it shipped from the factory).

- Factory Reset is irreversible.
- The Administrator Password (if set up) is required to perform a Factory Reset regardless of operator access settings.
- Performing a Factory Reset will reset Administrator and Operator passwords.

To return the 900 to Factory Reset from any “Detailed Operating Screen”

1. Tap the **ADJUST** button to enter EDIT Mode.
2. Tap the **SETTINGS** button.
3. Tap the “Advanced” field.
4. Tap the “Factory Reset” field.
5. The display will prompt you to verify you wish to perform a Factory Reset, tap the **ACCEPT** button.
6. The 900 will perform a Factory Reset, briefly display the Myron L® Company Logo, then display the Initial Setup screen. See Initial Setup (Section V) for instructions.



XI. CALIBRATION

Myron L® Company recommends periodic calibration of all input channels/sensors (except 4-20 mA Input). Calibration intervals depend on measurement type and application. You should always calibrate after initial installation, and after cleaning or replacing a sensor. Verify calibration regularly and any time readings are not as expected.

NOTE: The current condition of all associated relay(s)/alarm(s) will freeze while in Calibration Mode. Example: If a relay was triggered when you went into Calibration Mode, it will continue to be triggered until you exit Calibration Mode and the measured value returns to desired levels.

A. Conductivity, TDS, or Salinity Calibration

Input Channels: COND/RES1 and COND/RES2

The 900 Series only requires a single point calibration for conductivity, TDS, or salinity. Calibration is performed separately for each type of solution one wishes to measure, as well as for each input channel.

There are 3 calibration methods for Conductivity, TDS, or Salinity:

- **Wet Calibration:** The system is calibrated by removing the sensor from the pipe/tank and placing the sensor in a Calibration Standard Solution of a known value.
- **Transfer Standard Calibration:** The system is calibrated with the sensor inline as per normal operation, using a calibrated handheld instrument such as the Ultrameter II to measure the solution being tested (usually by use of a tap valve close to the sensor).
- **FAC CAL:** Resets the calibration for the specific solution type on the selected input channel back to factory calibration. This method erases any user-adjusted calibration and does not take the sensor condition into account.

1. Wet Calibration with Standard Solution

The BEST method of verifying and/or calibrating conductivity, TDS, and salinity is with NIST traceable Standard Solution (available from the Myron L® Company). Because it includes the sensor, the entire system is calibrated. Select a Standard Solution that is 60-90% of the maximum range of operation intended for the input channel (example: for conductivity measurement in the 0-2000 μ S range use KCl-1800). For greatest accuracy, wet calibration should be performed at or close to 25°C.

To perform a wet calibration:

1. Prepare the sensor and calibration solution:
 - a. Rinse a glass beaker then fill it with the Standard Solution.
 - b. Pour some of the Standard Solution over the sensor to rinse it off.
 - c. Place sensor in the beaker of Standard Solution. The level of Standard Solution must be high enough to cover at least 1/2" above bore hole(s)
 - d. Slowly stir the sensor in the Standard Solution to remove air bubbles from inside the sensor bore hole(s).
 - e. Allow 10 minutes for temperature to equilibrate. For the quickest and the best results, both the sensor and solution should be at the same temperature.

NOTE: During the calibration measurement and adjustment, be sure to keep the sensing electrodes submerged in the solution and away from the sides or bottom of the beaker.

2. Perform the wet calibration from the desired input channel's "Detailed Operating Screen":

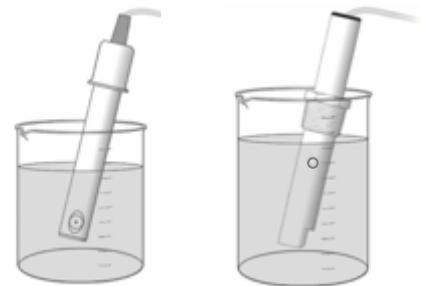

- a. Tap the **ADJUST** button to enter EDIT Mode.
 - b. Tap the primary measurement value displayed on the screen.
 - c. Using the up/down arrows, adjust the displayed reading to match the value stated on the bottle of Standard Solution.
 - d. Tap the **ACCEPT** button to accept the value and exit Calibration Mode.
3. Calibration is complete. Tap the gray measurement value to return to normal operating mode.

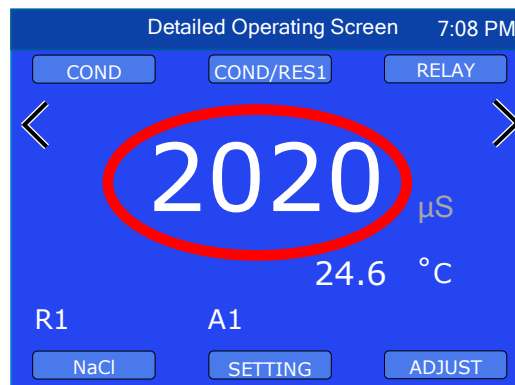

2. Transfer Standard Method of Calibration

For maximum accuracy of any conductivity, TDS, or salinity monitor/controller, the transfer standard method should be utilized. Instead of removing the sensor from the process system, or the entire monitor/controller and sensor, and either returning it to the manufacturer or sending it to a third party laboratory for recertification, the transfer standard allows quick recertification and return to service — less down time. While being the most accurate method it is also very easy to perform and may be used to calibrate any manufacture’s monitor/controller — conductivity, TDS, or salinity. This method still has the benefit of third party verification, if so desired.

A high quality hand-held instrument, one capable of accurate conductivity, TDS, and/or salinity readings such as the Myron L® Ultrameter II™, is calibrated using a NIST traceable Standard Solution, or if so desired, sent to a third party laboratory for calibration & certification. Preferably the hand-held instrument is calibrated with a standard solution as close as practicable to the area of the monitor/controller operation (example: for conductivity measurement in the 0-2000 µS range, the recommended Myron L® Standard Solution is KCl-1800).

To calibrate conductivity, TDS or Salinity using the Transfer Standard Method:

1. Using the calibrated hand-held instrument, measure the process liquid.
NOTE: If the sensor installation is inline, it is best to measure the process liquid by means of a tap valve as close to the inline sensor as possible.
2. Adjust the calibration of the monitor/controller to match the value measured by the Ultrameter II™.
From the desired input channel’s “Detailed Operating Screen”:

- a. Tap the **ADJUST** button to enter EDIT Mode.
 - b. Tap the primary measurement value displayed on the screen.
 - c. Using the up/down arrows, adjust the displayed reading to match the value measured by the Ultrameter II.
 - d. Tap the **ACCEPT** button to accept the value and exit Calibration Mode.
3. Calibration is complete. Tap the gray measurement value to return to normal operating mode.

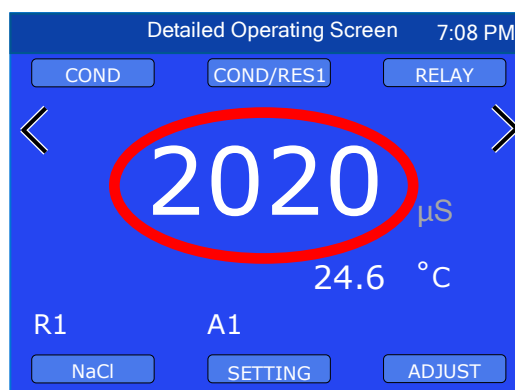

3. FAC CAL (Reloading Factory Calibration)

If calibration is suspect or known to be incorrect, and no method of calibration is available, the calibration can be returned to the original factory calibration. FAC CAL returns the instrument to a known state. The FAC CAL internal electronic calibration, does not take the sensor condition into consideration, and is NOT intended to replace calibration with conductivity/TDS standard solutions or transfer standard.

Returning a conductivity, TDS, or salinity measurement to FAC CAL will erase any user-adjusted calibration for the specific solution type on the selected input channel.

To return a measurement to FAC CAL from the desired input channel's "Detailed Operating Screen":

1. Tap the **ADJUST** button to enter EDIT Mode.
2. Tap the primary measurement value displayed on the screen.
3. Tap the **FAC CAL** button on the bottom center of the screen.
4. Tap the **ACCEPT** button.
5. FAC CAL is complete. Tap the gray measurement value to return to normal operating mode.

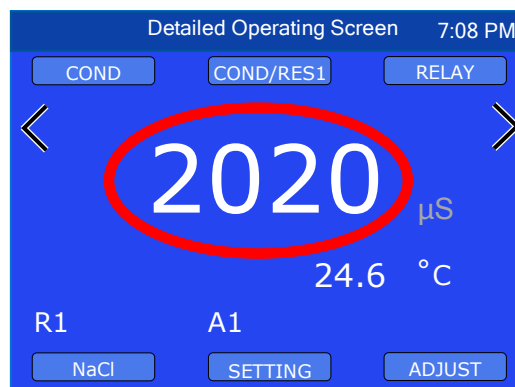

B. Resistivity Calibration

Input Channels: COND/RES1 and COND/RES2

The 900 Series only requires a single point calibration for Resistivity. Calibration is performed separately for each type of solution one wishes to measure, as well as for each input channel.

There are 3 calibration methods for Resistivity:

- **Transfer Standard Calibration:** The system is calibrated with the sensor inline as per normal operation, using a calibrated handheld instrument such as the Ultrameter II to measure the solution being tested (usually by use of a tap valve close to the sensor).
- **Sensor Substitute:** Using precision resistors to verify the electronics. This method does not take the sensor condition into account.
- **FAC CAL:** Resets the calibration for the specific solution type on the selected input channel back to factory calibration. This method erases any user-adjusted calibration and does not take the sensor condition into account.

1. Transfer Standard Method of Calibration

For maximum accuracy of any resistivity monitor/controller, the transfer standard method should be utilized. Instead of removing the sensor from the process system, or the entire monitor/controller and sensor, and either returning it to the manufacturer or sending it to a third party laboratory for recertification, the transfer standard allows quick recertification and return to service — less down time. While being the most accurate method it is also very easy to perform and may be used to calibrate ANY manufacture's resistivity monitor/controller. This method still has the benefit of third party verification, if so desired.

Necessary equipment: A high quality hand-held instrument, one capable of accurate resistivity readings such as the Myron L® Ultrameter II™, is calibrated using a NIST traceable Standard Solution, or if so desired, sent to a third party laboratory for calibration & certification.

To calibrate the 900 resistivity using the Transfer Standard Method:

1. Using the calibrated hand-held instrument, measure the process liquid.
NOTE: If the sensor installation is inline, it is best to measure the process liquid by means of a tap valve as close to the inline sensor as possible.
2. Adjust the calibration of the monitor/controller to match the value measured by the Ultrameter II:
 - a. From the desired input channel's "Detailed Operating Screen".
 - b. Tap the **ADJUST** button to enter EDIT Mode.

- c. Tap the primary measurement value displayed on the screen.
 - d. Using the up/down arrows, adjust the displayed reading to match the value measured by the Ultrameter II.
 - e. Tap the **ACCEPT** button to accept the value and exit Calibration Mode.
3. Calibration is complete. Tap the gray measurement value to return to normal operating mode.

2. Sensor Substitute

NIST traceable Sensor Substitutes are commonly used to calibrate resistivity monitor/controllers. Normally they are not necessary on the 900 Series due to its precision electronics. However, your requirements may be such that a crosscheck or verification is required. For this reason, a NIST traceable 20 MΩ Sensor Substitute is available from the Myron L® Company, order model CS9-11.

To calibrate/verify the resistivity using a Sensor Substitute:

1. Remove the sensor connector from the back of the 900.
2. Plug the Sensor Substitute into the desired resistivity terminal block (CONDRES1/CONDRES2) on the back of the 900.
3. Set the sensor cable length to zero:
 - a. Tap the **ADJUST** button to enter EDIT Mode.
 - b. Tap the Input Channel button on the top center of the screen.
 - c. Tap the **ACCEPT** button to bypass sensor selection.
 - d. Tap the “Cable Length” field.
 - i. Record the cable length to reprogram after verification.
 - e. Using the keypad, change the cable length to 0.00 then tap “Enter”.
4. Set the Cell Constant to 0.0500:
 - a. Tap the “Cell Constant” field.
 - i. Record the sensor’s cell constant to reprogram after verification.
 - b. Using the keypad, change the cell constant to 0.05000 then tap “Enter”.
 - c. Tap the **ACCEPT** button.
 - i. If performing a verification skip to Line 6.

-or-

 - ii. If performing a calibration continue to Line 5.
5. Perform the calibration from the desired input channel’s “Detailed Operating Screen”:
 - a. Tap the **ADJUST** button to enter EDIT Mode.
 - b. Tap the primary measurement value displayed on the screen to enter Calibration Mode.
 - c. Using the up/down arrows, adjust the displayed reading to match the value of the sensor substitute.
 - d. Tap the **ACCEPT** button to accept the value and exit Calibration Mode.
6. Remove the Sensor Substitute.
7. Reconnect the sensor.

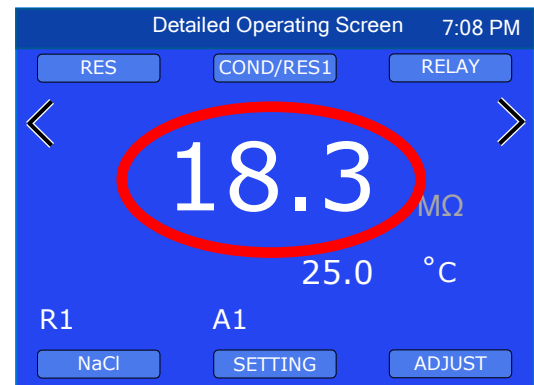
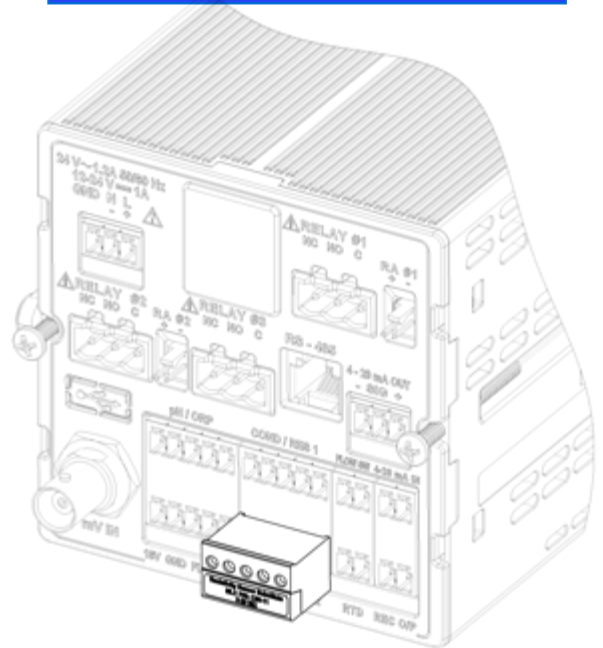
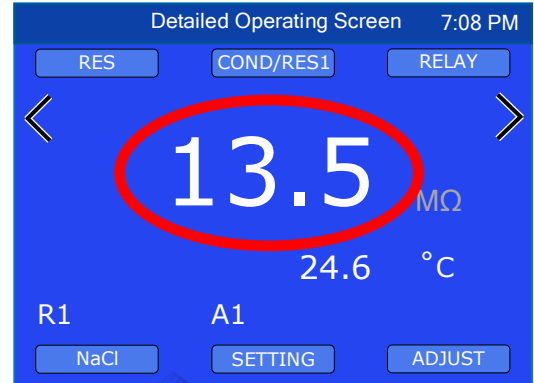

8. Reprogram the correct sensor cable length:
 - a. Tap the **ADJUST** button to enter EDIT Mode.
 - b. Tap the Input Channel button on the top center of the screen.
 - c. Tap the **ACCEPT** button to bypass sensor selection.
 - d. Tap the “Cable Length” field.
 - e. Using the keypad, enter the cable length, then tap “Enter”.
9. Reprogram the Cell Constant:
 - a. Tap the “Cell Constant” field.
 - b. Using the keypad, enter the sensor’s cell constant, then tap “Enter”.
 - c. Tap the **ACCEPT** button.
10. Verification/calibration is complete. Tap the gray measurement value to return to normal operating mode.

NOTE: If the 20 MΩ Resistivity Sensor Substitute is not readily available and you cannot wait for one to be delivered, or you need a different value, one may be constructed using the equivalent resistor values listed on the chart below.

900 Series Resistivity Sensor Substitute Resistor Values		
Measurement Value	Resistor Value for R1	Resistor Value for R2
20 MΩ	1.1 kΩ	1.0 MΩ
10 MΩ	1.1 kΩ	500 kΩ
5 MΩ	1.1 kΩ	249 kΩ
2 MΩ	1.1 kΩ	100 kΩ
1 MΩ	1.1 kΩ	50 kΩ
500 kΩ	1.1 kΩ	24.9 kΩ
200 kΩ	1.1 kΩ	10 kΩ

NOTE: All resistors should be ± 0.1% tolerance.

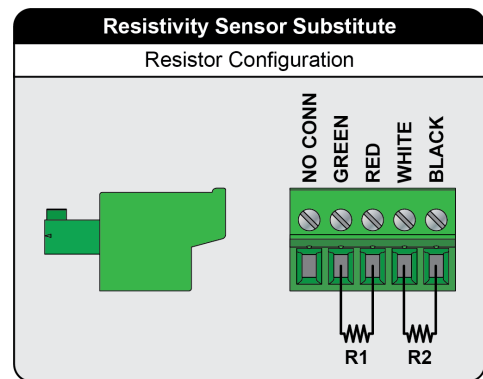

3. FAC CAL (Reloading Factory Calibration)

If calibration is suspect or known to be incorrect, and no method of calibration is available, the calibration can be returned to the original factory calibration. FAC CAL returns the instrument to a known state. The FAC CAL internal electronic calibration does not take the sensor condition into consideration and is NOT intended to replace calibration with a transfer standard.

Returning a resistivity measurement to FAC CAL will erase any user-adjusted calibration for the specific solution type on the selected input channel.

To return a measurement to FAC CAL from the desired input channel’s “Detailed Operating Screen”.

1. Tap the **ADJUST** button to enter EDIT Mode.
2. Tap the primary measurement value displayed on the screen to enter Calibration Mode.
3. Tap the **FAC CAL** button on the bottom center of the screen.
4. Tap the **ACCEPT** button.
5. FAC CAL is complete. Tap the gray measurement value to return to normal operating mode.

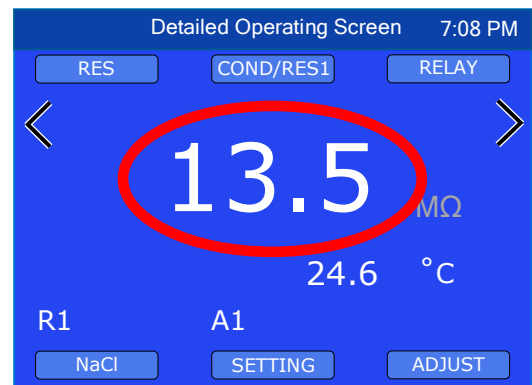

C. pH Calibration

Input Channels: pH/ORP and mV IN

pH calibration is performed separately for each input channel; pH/ORP or mV IN.
pH calibration affects both pH measurement types; pH and pH (TC Off) on the selected input channel.

There are 3 calibration methods for pH:

- **Wet Calibration:** The system is calibrated by removing the sensor from the pipe/tank and placing the sensor in pH buffer solutions.
- **Transfer Standard Calibration:** The system is calibrated with the sensor inline as per normal operation, using a calibrated handheld instrument such as the Ultrameter II to measure the solution being tested (usually by use of a tap valve close to the sensor).
- **FAC CAL:** Resets the pH calibration on the selected input channel back to factory calibration. This method erases any user-adjusted calibration and does not take the sensor condition into account.

1. pH Calibration with Buffer Solution(s)

The BEST method of calibrating your pH monitor/controller is doing a 3-Point wet calibration with NIST traceable pH buffer solutions (available from the Myron L[®] Company). Because it includes the sensor, the entire system is calibrated.

The 900 Series offers 1, 2, or 3-point pH calibration. You should always calibrate your instrument with a pH 7 buffer solution before adjusting the gain with acid or base buffers, i.e., 4 and/or 10. Either acid or base solution can be used for the 2nd point “Gain” calibration and then the opposite for the 3rd point. If you will be performing a 2-point calibration, select pH 7 and the buffer closest to your measurement range (example: if your normal measurement range is below 7 pH, you would select pH 7 and pH 4 buffers). If you will only be performing a single point calibration, use pH 7 buffer solution.

NOTES:

- The uncalibrated (raw) pH value will be displayed while the 900 is in pH 7.00 calibration. This will assist in determining the accuracy of the pH sensor. If the pH reading is above 8 or below 6 with the sensor in pH 7 buffer solution, the sensor needs additional rinsing, the sensor needs to be cleaned, or the pH sensor is defective and needs to be replaced.
- For best results, all pH buffers and the pH sensor should be at the same temperature.
- If you are calibrating a pH sensor without temperature compensation, make sure the pH buffers and the sensor are at 25°C.

a) Perform a 3-Point pH Calibration

The following items are necessary for a 3-point pH calibration: pH buffer solutions; 4, 7 and 10, water (preferably DI, RO, or distilled) for rinsing the sensor before calibration and between buffers, and clean dry cloths such as *Kimwipes*[™] (to pat the sensor dry).

1. Prepare for calibration:
 - a. Fill one beaker with each pH buffer to be used (4, 7, and 10) and one beaker with water (preferably DI, RO, or distilled) for rinsing. Leave enough space in the top to prevent overflow when the sensor is submerged.
 - b. Rinse the sensor in the rinse water and pat it dry.
 - i. Use caution not to harm the glass electrode.
 - c. Place the pH sensor in the pH 7 buffer and stir to remove any bubbles. The level of pH buffer must be high enough to cover at least 1/2” above the sensing electrode.
 - d. Allow the reading to stabilize.

2. Put the 900 into pH Calibration Mode:
 - a. Tap the **ADJUST** button on the desired input channel's "Detailed Operating Screen" to enter EDIT Mode.
 - b. Tap the primary measurement value displayed on the screen to enter Calibration Mode.
3. Perform the first calibration point (pH 7):
 - a. Verify the reading has stabilized, then using the up/down arrows, adjust the displayed reading to match the value stated on the bottle of pH buffer.
 - b. Tap the **ACCEPT** button to accept the value and continue to the 2nd calibration point.
4. Perform the 2nd calibration point:
 - a. Rinse the sensor in the rinse water and pat dry.
 - b. Place the pH sensor in the pH 4 (or pH 10) buffer and stir to remove any bubbles. The level of pH buffer must be high enough to cover at least 1/2" above the sensing electrode.
 - c. Verify the reading has stabilized, then using the up/down arrows, adjust the displayed reading to match the value stated on the bottle of pH buffer.
 - d. Tap the **ACCEPT** button to accept the value and continue to the 3rd calibration point.
5. Perform the 3rd calibration point:
 - a. Rinse the sensor in the rinse water and pat dry.
 - b. Place the pH sensor in the pH 10 (or pH 4) buffer and stir to remove any bubbles. The level of pH buffer must be high enough to cover at least 1/2" above the sensing electrode.
 - c. Verify the reading has stabilized, then using the up/down arrows, adjust the displayed reading to match the value stated on the bottle of pH buffer.
 - d. Tap the **ACCEPT** button to accept the value exit Calibration Mode.
6. Calibration is complete. Tap the gray measurement value to return to normal operating mode.

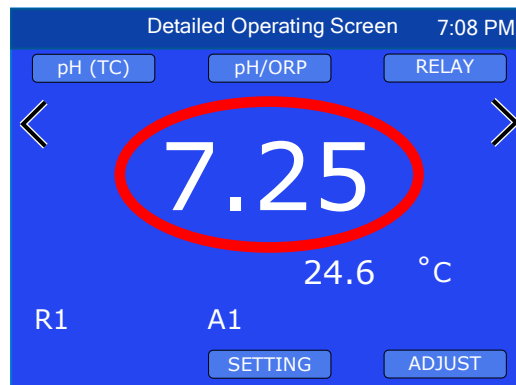

b) Perform a 2-Point pH Calibration

The following items are necessary for a 2-point pH calibration: pH buffer solutions; 7 and 4 or 10, water (preferably DI, RO, or distilled) for rinsing the sensor before calibration and between buffers, and clean dry cloths such as *Kimwipes™* (to pat the sensor dry).

1. Prepare for calibration:
 - a. Fill one beaker with each pH buffer to be used (7 and 4 or 10) and one beaker with water (preferably DI, RO, or distilled) for rinsing. Leave enough space in the top to prevent overflow when the sensor is submerged.
 - b. Rinse the sensor in the rinse water and pat it dry.
 - i. Use caution not to harm the glass electrode.
 - c. Place the pH sensor in the pH 7 buffer and stir to remove any bubbles. The level of pH buffer must be high enough to cover at least 1/2" above the sensing electrode.
 - d. Allow the reading to stabilize.
2. Put the 900 into pH Calibration Mode:
 - a. Tap the **ADJUST** button on the desired input channel's "Detailed Operating Screen" to enter EDIT Mode.
 - b. Tap the primary measurement value displayed on the screen to enter Calibration Mode.
3. Perform the first calibration point (pH 7):
 - a. Verify the reading has stabilized, then using the up/down arrows, adjust the displayed reading to match the value stated on the bottle of pH buffer.
 - b. Tap the **ACCEPT** button to accept the value and continue to the 2nd calibration point.
4. Perform the 2nd calibration point (pH 4 or 10):
 - a. Rinse the sensor in the rinse water and pat dry.

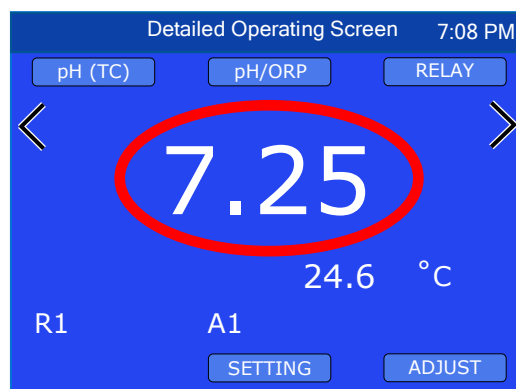

- b. Place the pH sensor in the pH 4 (or pH 10) buffer solution and stir to remove any bubbles. The level of pH buffer must be high enough to cover at least 1/2" above the sensing electrode.
- c. Verify the reading has stabilized, then using the up/down arrows, adjust the displayed reading to match the value stated on the bottle of pH buffer.
- d. Tap the **ACCEPT** button to accept the value.
- e. Tap the **ESC** button to exit pH calibration. The same gain will be applied to both acid and base.

c) Perform a 1-Point pH Calibration

The following items are necessary for a 1-point pH calibration: pH buffer solutions; 7, water (preferably DI, RO, or distilled) for rinsing the sensor before calibration and clean dry cloths such as *Kimwipes™* (to pat the sensor dry).

1. Prepare for calibration:
 - a. Fill one beaker with the pH buffer to be used, and one beaker with water (preferably DI, RO, or distilled) for rinsing. Leave enough space in the top to prevent overflow when the sensor is submerged.
 - b. Rinse the sensor in the rinse water and pat it dry.
 - i. Use caution not to harm the glass electrode.
 - c. Place the pH sensor in the pH buffer and stir to remove any bubbles. The level of pH buffer must be high enough to cover at least 1/2" above the sensing electrode.
 - d. Allow the reading to stabilize.
2. Put the 900 into pH Calibration Mode:
 - a. Tap the **ADJUST** button on the desired input channel's "Detailed Operating Screen" to enter EDIT Mode.
 - b. Tap the primary measurement value displayed on the screen to enter Calibration Mode.
 - i. Although it is not recommended, if you wish to perform a single point calibration using pH 4 or pH 10, tap the **ACCEPT** button to bypass pH 7 and continue on to gain calibration.
3. Perform the 1-Point Calibration:
 - a. Verify the reading has stabilized, then using the up/down arrows, adjust the displayed reading to match the value stated on the bottle of pH buffer.
 - b. Tap the **ACCEPT** button to accept the value.
 - c. Tap the **ESC** button to accept the 1-point calibration and exit Calibration Mode.
 - i. If the 1-Point calibration was performed with pH 4 (or pH 10), the gain will only be applied to the acid (if pH 4 was used) or base (if pH 10 was used).

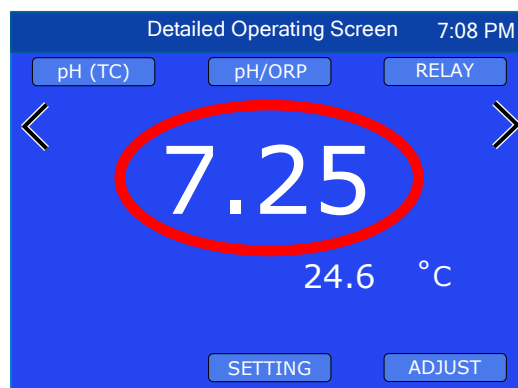

2. Transfer Standard Calibration

Another method of calibrating a 900 Series pH measurement is via the transfer standard. Instead of removing the pH sensor from the process system, or the entire monitor/controller and sensor, and either returning it to the manufacture or sending it to a third party laboratory for recertification, the transfer standard allows for a quick check and return to service with less down time. It is very easy to perform, and this method still has the benefit of third party verification, if so desired. This method does have its limitations when calibrating a pH measurement and should NOT be used if the measurement is expected to operate in a wide range.

A high quality hand-held instrument, one capable of accurate pH readings, such as the Myron L® Ultrameter II™ 6P, is calibrated using pH buffer solutions (4, 7 & 10), or if so desired, sent to a third party laboratory for calibration & certification. Once the Ultrameter II is calibrated, the process solution is measured and recorded. The 900 Series pH measurement is then calibrated/adjusted to match the measured value.

A single point transfer standard calibration adjustment depends on the value:

6.00 to 8.00 pH – Adjusts the offset

< 6.0 pH – Adjusts the gain for acid

> 8.0 pH – Adjusts the gain for base

To perform a 1-point transfer standard pH calibration:

- Using the calibrated hand-held instrument, measure the process liquid.

NOTE: If the sensor installation is inline, it is best to measure the process liquid by means of a tap valve as close to the inline sensor as possible.

- Put the 900 into pH Calibration Mode:
 - Tap the **ADJUST** button on the desired input channel's "Detailed Operating Screen" to enter EDIT Mode.
 - Tap the primary measurement value displayed on the screen to enter Calibration Mode.
 - If the measured value of the process solution pH is <6.00 or >8.00, tap the **ACCEPT** button to bypass pH 7 and continue to the gain calibration.
- Perform the 1-point Calibration:
 - Using the up/down arrows, adjust the displayed reading to match the measured value.
 - Tap the **ACCEPT** button to accept the value.
 - Tap the **ESC** button to accept the 1-point calibration and exit Calibration Mode.

3. FAC CAL (Reloading Factory Calibration)

If calibration is suspect or known to be incorrect, and no method of calibration is available, the calibration can be returned to the original factory calibration. FAC CAL returns the instrument to a known state. The FAC CAL internal electronic calibration, does not take the sensor condition into consideration, and is NOT intended to replace calibration with pH buffers.

NOTE: Returning a pH measurement to FAC CAL will erase all user-adjusted calibration for the pH and pH (TC Off), on the selected input channel.

To return a pH measurement to FAC CAL:

- Tap the **ADJUST** button on the desired input channel's "Detailed Operating Screen" to enter EDIT Mode.
- Tap the primary measurement value displayed on the screen to enter Calibration Mode.
- Tap the **FAC CAL** button on the bottom center of the screen.
- Tap the **ACCEPT** button to accept the FAC CAL and exit Calibration Mode.

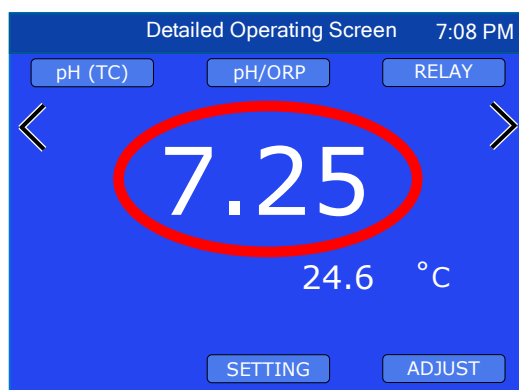
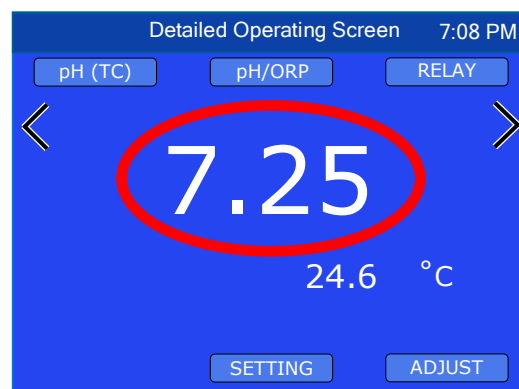

D. ORP Calibration

Input Channels: pH/ORP and mV IN.

The precision electronics in the 900 Series ORP circuitry does not require calibration. However, if you wish to adjust the offset of a sensor to match a known reference, the 900 offers a single point calibration. ORP calibration is performed separately for each input channel.

NOTE: On the pH/ORP input channel, calibration of the ORP and mV measurement types are linked.

There are 3 calibration methods for ORP:

- **Wet Calibration:** The system is calibrated by removing the sensor from the pipe/tank and placing the sensor in an ORP standard solution.
- **Transfer Standard Calibration:** The system is calibrated with the sensor inline as per normal operation, using a calibrated handheld instrument such as the Ultrameter II™ 6P FC^E to measure the solution being tested (usually by use of a tap valve close to the sensor).
- **FAC CAL:** Resets the ORP calibration on the selected input channel back to factory calibration. This method erases any wet calibration and does not take the sensor condition into account.

1. ORP Calibration with Standard Solution

1. Prepare for calibration:
 - a. Fill a beaker with the calibration standard solution to be used. Be sure to leave enough space in the top to prevent overflow when the sensor is submerged.
 - b. Rinse the sensor with water (preferably DI, RO, or distilled) and pat it dry.
 - c. Place the ORP sensor in the calibration solution and stir to remove any bubbles. The level of calibration solution must be high enough to cover at least 1/2" above the sensing electrode.
 - d. Allow the temperature of the sensor and solution to come to equilibrium.
NOTE: ORP does not have temperature compensation, so any disparity from 25°C must be accounted for during calibration.
2. Put the 900 into ORP Calibration Mode:
 - a. Tap the **ADJUST** button on the desired input channel's "Detailed Operating Screen" to enter EDIT Mode.
 - b. Tap the primary measurement value displayed on the screen to enter Calibration Mode.
3. Perform the calibration:
 - a. Verify the reading has stabilized, then using the up/down arrows, adjust the displayed reading to match the value of the calibration standard solution.
 - b. Tap the **ACCEPT** button to accept the value and exit Calibration Mode.

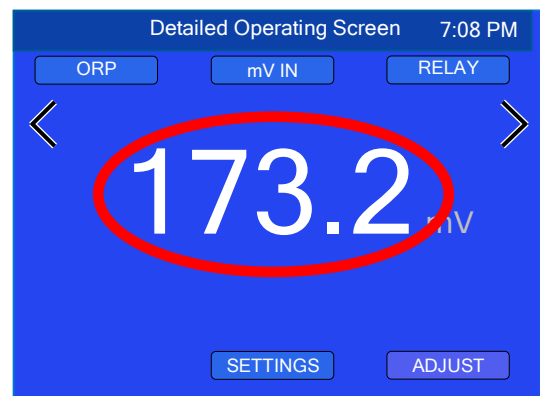

2. Transfer Standard Calibration

Another method of calibrating the 900 Series ORP measurements is via the transfer standard. Instead of removing the ORP sensor from the process system, or the entire monitor/controller and sensor, and either returning it to the manufacture or sending it to a third party laboratory for recertification, the transfer standard allows for a quick check and return to service with less down time. It is very easy to perform, and this method still has the benefit of third party verification, if so desired. This method works very well with an ORP measurement as span drift is usually not common in quality sensors.

A high quality hand-held instrument, one capable of accurate ORP readings, such as the Myron L® Ultrameter II™ 6P FC^E is calibrated, or if so desired, sent to a third party laboratory for certification. Once the Ultrameter is calibrated, the process solution is measured and recorded. The 900 Series ORP measurement is then calibrated/adjusted to match the measured value.

To perform a transfer standard ORP calibration:

1. Using the calibrated hand-held instrument, measure the process liquid.
NOTE: If the sensor installation is inline, it is best to measure the process liquid by means of a tap valve as close to the inline sensor as possible.
2. Put the 900 into ORP Calibration Mode:
 - a. Tap the **ADJUST** button on the desired input channel's "Detailed Operating Screen" to enter EDIT Mode.
 - b. Tap the primary measurement value displayed on the screen to enter Calibration Mode.
3. Perform the calibration:
 - a. Using the up/down arrows, adjust the displayed reading to match the measured value.
 - b. Tap the **ACCEPT** button to accept the calibration adjustment and exit Calibration Mode.

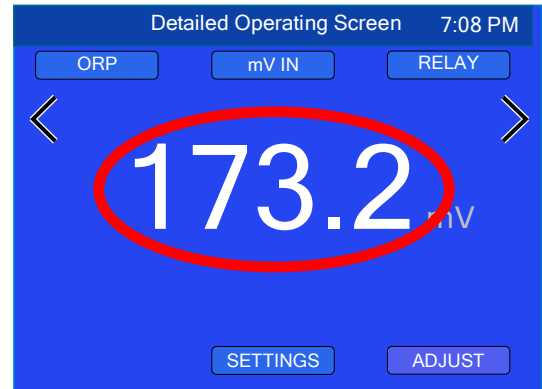

3. FAC CAL (Reloading Factory Calibration)

If calibration is suspect or known to be incorrect, and no method of calibration is available, the calibration can be returned to the original factory calibration. FAC CAL returns the instrument to a known state. The FAC CAL internal electronic calibration, does not take the sensor condition into consideration, and is NOT intended to replace calibration with standard solution or transfer standard.

Returning an ORP measurement to FAC CAL will erase any user-adjusted calibration for the specific measurement type on the selected input channel.

NOTE: On the pH/ORP input channel, calibration of the ORP and mV measurement types are linked.

To return an ORP measurement to FAC CAL:

1. Tap the **ADJUST** button on the desired input channel's "Detailed Operating Screen" to enter EDIT Mode.
2. Tap the primary measurement value displayed on the screen to enter Calibration Mode.
3. Tap the **FAC CAL** button on the bottom center of the screen.
4. Tap the **ACCEPT** button to accept the FAC CAL and exit Calibration Mode.

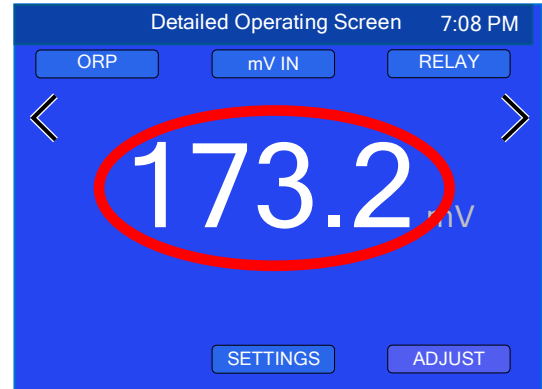

E. Temperature Calibration

The Myron L® Company sensors utilize precision RTD temperature sensors and should not require calibration. However, the 900 does offer a single point calibration to allow you to adjust the temperature to a known value.

NOTE: Temperature calibration is unique to each input channel (Example: calibrating the RTD input channel does not affect the COND/RES1 input channel's temperature).

NOTE: Use caution when adjusting temperature calibration as it affects the measurement values of an associated temperature compensated parameter. For example, while adjusting the temperature calibration of a conductivity sensor, the conductivity value will change accordingly.

There are 3 calibration methods for temperature:

- **Wet Calibration:** The system is calibrated by removing the sensor from the pipe/tank and placing the sensor in a temperature controlled water bath (calibration bath) or ice slurry.
- **Sensor Substitute:** Using precision resistors to verify the electronics. This method does not take the sensor condition into account.
- **FAC CAL:** Resets the temperature calibration on the selected input channel back to factory calibration. This method erases any wet calibration and does not take the sensor condition into account.

1. Wet Calibration

a) Wet calibration using a temperature controlled water bath:

1. Place the sensor in the water bath deep enough to cover at least ½" above the sensing electrode.
2. Slowly stir the sensor in the solution to remove any air bubbles.
3. Allow 10 minutes for the temperature of the sensor and solution to come to equilibrium.
4. Perform the calibration:
 - a. Tap the **ADJUST** button on the desired input channel's "Detailed Operating Screen" to enter EDIT Mode.
 - b. Tap the temperature measurement value displayed on the screen. The display will go to the temperature "Calibration" screen.
 - c. Using the up/down arrows, adjust the value as necessary.
 - d. Tap the **ACCEPT** button to accept the calibration and return to the "Detailed Operating Screen".

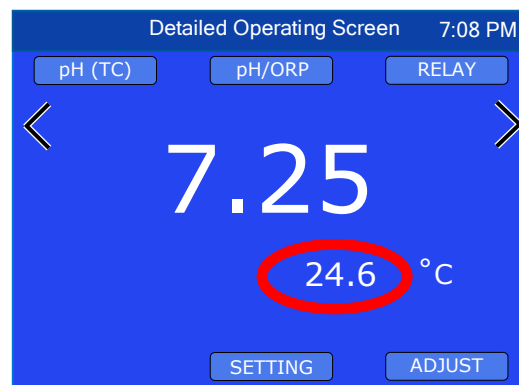

b) Wet calibration using an ice slurry:

If a temperature controlled water bath is not available, an ice slurry may be used.

An ice slurry is a mixture of crushed ice and water where there is only enough water present to allow easy stirring. At this point, the temperature of the water will be 0.00°C.

1. Create an ice slurry (preferably in an insulated container).
2. Immerse the sensor approximately 2in./50mm into slurry.
3. Allow the sensor and slurry to equilibrate. Slurry must be constantly stirred.
4. Continue stirring until no further change in temperature is observed on the display.
5. Perform the calibration:
 - a. Tap the **ADJUST** button on the desired input channel's "Detailed Operating Screen" to enter EDIT Mode.

- b. Tap the temperature measurement value displayed on the screen. The display will go to the temperature “Calibration” screen.
- c. Using the up/down arrows, adjust the temperature value to 0.0°.
- d. Tap the **ACCEPT** button to accept the calibration and return to the “Detailed Operating Screen”.

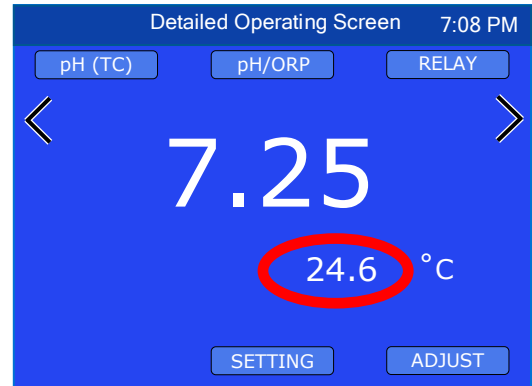

2. Sensor Substitute, Temperature

NIST traceable Sensor Substitutes may be used to verify and/or calibrate temperature monitor/controllers. Normally they are not necessary on the 900 Series due to its precision electronics. However, your requirements may be such that a crosscheck or verification is required. For this reason, NIST traceable temperature sensor substitutes for use with COND/RES1, COND/RES2 and RTD input channels are available from the Myron L® Company, order model TPC9.

To calibrate a 900 Series temperature input using a sensor substitute:

1. Remove the sensor connector from the back of the 900.
2. Plug the Sensor Substitute into the temperature signal input of the desired input channel on the back of the 900.
NOTE: The temperature sensor substitute is not polarized.
3. Set the sensor cable length to zero:
From the desired input channel’s “Detailed Operating Screen”:
 - a. Tap the **ADJUST** button to enter EDIT Mode.
 - b. Tap the Input Channel button on the top center of the screen.
 - c. For the COND/RES1 or COND/RES2 input channels: Tap the **ACCEPT** button to bypass sensor selection.
 - d. Tap the “Cable Length” field.
NOTE: Record the sensor cable length to reprogram after calibration.
 - e. Using the keypad, change the cable length to 0.00 then tap “Enter”.
 - f. Tap the **ACCEPT** button.
4. Perform the calibration:
 - a. Tap the **ADJUST** button on the desired input channel’s “Detailed Operating Screen” to enter EDIT Mode.
 - b. Tap the temperature measurement value displayed on the screen.
 - c. Using the up/down arrows, adjust the displayed reading to match the value of the sensor substitute. This value is located on the sensor substitute label.
 - d. Tap the **ACCEPT** button to accept the value and exit Calibration Mode.

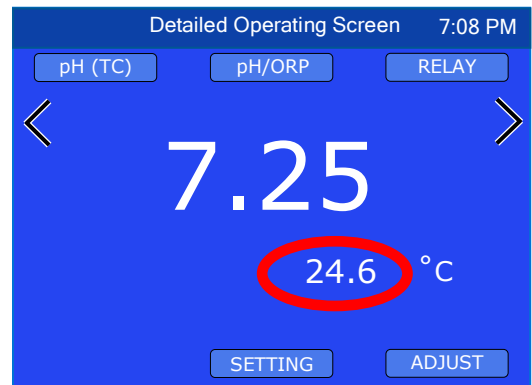
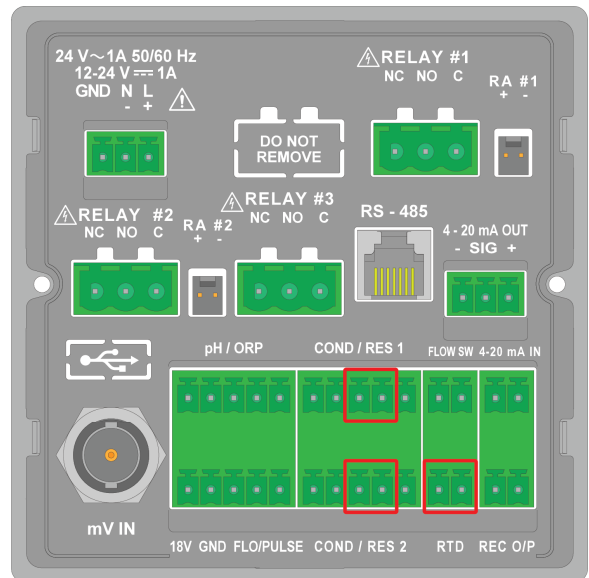

5. Remove the Sensor Substitute.
6. Reconnect the sensor.
7. Reprogram the correct Sensor Cable Length.
From the desired input channel's "Detailed Operating Screen":
 - a. Tap the **ADJUST** button to enter EDIT Mode.
 - b. Tap the Input Channel button on the top center of the screen.
 - c. For the COND/RES1 or COND/RES2 input channels: Tap the **ACCEPT** button to bypass sensor selection.
 - d. Tap the "Cable Length" field.
 - e. Using the keypad, enter the cable length then tap "Enter".
 - f. Tap the **ACCEPT** button.
8. Calibration is complete. Tap the gray measurement value to return to normal operating mode.

3. FAC CAL (Reloading Factory Calibration)

If temperature calibration is suspect or known to be incorrect, the calibration can be returned to the original factory calibration. FAC CAL returns the temperature to a known state.

To return a temperature measurement to FAC CAL:

1. Tap the **ADJUST** button on the desired input channel's "Detailed Operating Screen" to enter EDIT Mode.
2. Tap the temperature measurement value displayed on the screen to go to the temperature "Calibration" screen.
3. Tap the **FAC CAL** button on the bottom center of the screen.
4. Tap the **ACCEPT** button to accept the FAC CAL and exit Calibration Mode.

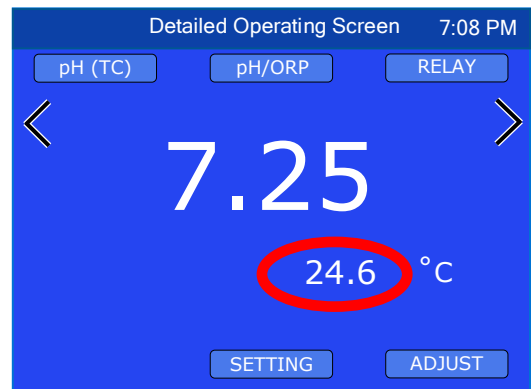

F. 4-20mA Output Calibration

1. Electronic Calibration

The optional 4-20mA Output was calibrated at the factory; however, if you wish to check the calibration the following procedure will help you accomplish the task. These instructions assume the 4-20mA Output settings are already configured.

Required equipment: Digital Volt Meter (DVM) set to DC milliamps.

1. Connect the DVM to the 900's 4-20mA Output as shown, selecting either the self-powered or remote powered example per your application.
2. Set the DVM to mA.

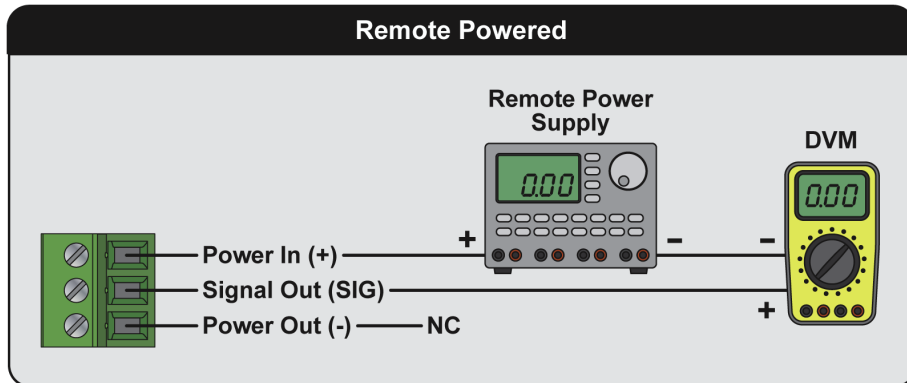
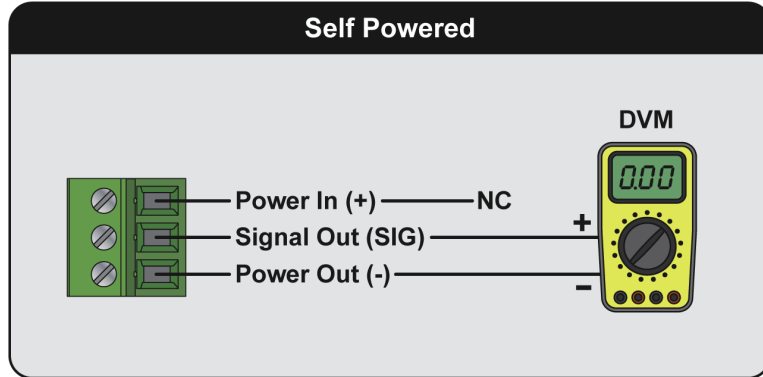

3. Put the 900 into 4-20mA Output Calibration Mode:
 - a. From any “Detailed Operating Screen”, tap the **ADJUST** button on the lower right side of the screen to enter EDIT Mode.
 - b. Tap the **SETTINGS** button in the bottom center of the screen.
 - c. Tap on the “Advanced” field.
 - d. Tap the “Output” field.
 - e. Tap the “4-20mA” (or “0-20mA”) field.
 - f. Tap the “Calibration” field.
4. Calibrate the offset (4mA output):
 - a. Adjust the display to match the DVM value.
5. Tap the **ACCEPT** button.
6. Calibrate the full scale (20mA output):
 - a. Adjust the display to match the DVM value.
7. Tap the **ACCEPT** button to accept the value and exit Calibration Mode

2. FAC CAL (Reloading Factory Calibration)

To return the 4-20mA Output to factory calibration:

1. From any “Detailed Operating Screen”, tap the **ADJUST** button on the lower right side of the screen to enter EDIT Mode.
2. Tap the **SETTINGS** button.
3. Tap on the “Advanced” field.
4. Tap the “Output” field.
5. Tap the “4-20mA” field.
6. Tap the “Calibration” field.
7. Tap the **FAC CAL** button.
8. Tap the **ACCEPT** button to accept the FAC CAL and exit Calibration Mode

G. 0-10 VDC Recorder Output Calibration

1. Electronic Calibration

The 0-10 VDC Recorder Output was calibrated at the factory; however, if you wish to adjust the calibration follow the procedure below. These instructions assume the 0-10 VDC Output settings are already configured.

Required equipment: Digital Volt Meter (DVM)

To Calibrate the 0-10VDC Output:

1. Attach the DVM:
 - a. Attach a voltmeter to the Recorder Output (REC O/P) connector on the back of the instrument, (positive on the left and negative on the right).
 - b. Set the DVM to DC Volts.
2. Put the 900 in 0-10 VDC Output Calibration Mode:
 - a. From any “Detailed Operating Screen”, Tap the **ADJUST** button to enter EDIT Mode.
 - b. Tap the **SETTINGS** button.
 - c. Tap the “Advanced” field.
 - d. Tap the “Output” field.
 - e. Tap the “0-10 V” field.
 - f. Tap the “Calibration” field.
3. Calibrate the offset (0 Volt).
 - a. Using the up and down arrows, adjust the voltage to match the DVM.
 - b. Tap the **ACCEPT** button.
4. Calibrate the full scale (10 Volt).
 - a. Using the up and down arrows, adjust the voltage to match the DVM.
 - b. Tap the **ACCEPT** button, the display will return to the “Set Up 0-10V Output” screen.
5. 0-10 VDC output calibration is complete.

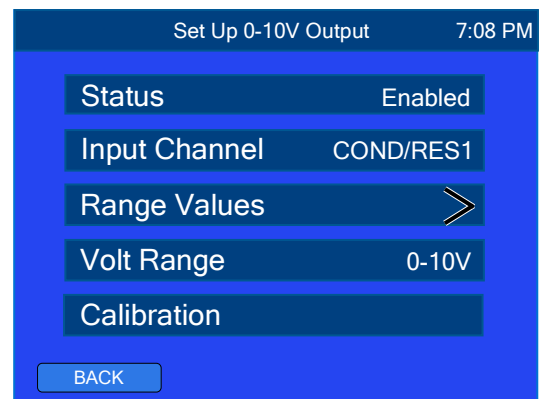
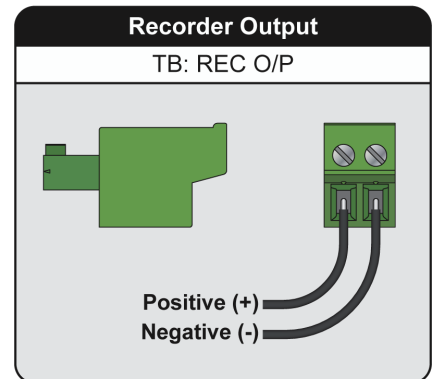

2. FAC CAL (Reloading Factory Calibration)

FAC CAL: Returns the 0-10VDC Output to factory calibration, erasing any previous calibration adjustment.

To return the 0-10VDC Output to FAC CAL:

1. Put the 900 in 0-10 VDC Output Calibration mode:
 - a. From any “Detailed Operating Screen”, Tap the **ADJUST** button to enter EDIT Mode.
 - b. Tap the **SETTINGS** button.
 - c. Tap the “Advanced” field.
 - d. Tap the “Output” field.
 - e. Tap the “0-10 V” field.
 - f. Tap the “Calibration” field.
2. Tap the **FAC CAL** button on the bottom center of the screen.
3. Tap the **ACCEPT** button. The display will return to the “Set Up 0-10V Output” screen.

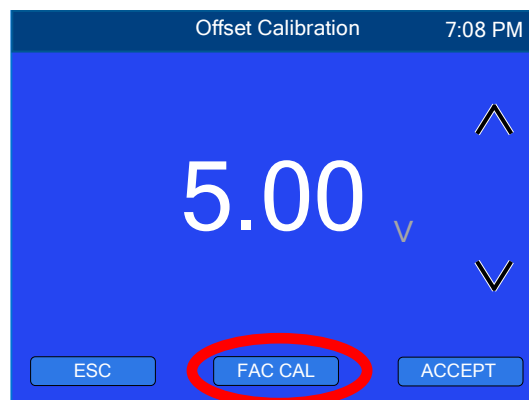

XII. REFERENCE INFORMATION

A. Temperature Compensation (Tempco) of Aqueous Solutions

Electrical conductivity indicates solution concentration and ionization of the dissolved material. Since temperature greatly affects ionization, conductivity measurements are temperature dependent and are normally corrected to read what they would be at 25°C.

1. Standardized to 25°C

Conductivity is measured with great accuracy in the 900 and features a microprocessor to perform temperature compensation. In simpler instruments, conductivity values are usually assigned an average correction similar to that of KCl solutions for correction to 25°C. The correction to an equivalent KCl solution is a standard set by chemists that standardizes the measurements and allows calibration with precise KCl solutions. In the 900, this correction can be set to other solutions or tailored for special measurements or applications.

2. Tempco Variation

Most conductivity instruments use an approximation of the temperature characteristics of solutions, perhaps even assuming a constant value. The value for KCl is often quoted simply as 2%/°C. In fact, KCl tempco varies with concentration and temperature in a non-linear fashion. Other solutions have more variation still. The 900 uses corrections that change with concentration and temperature instead of single average values. See Chart 1.

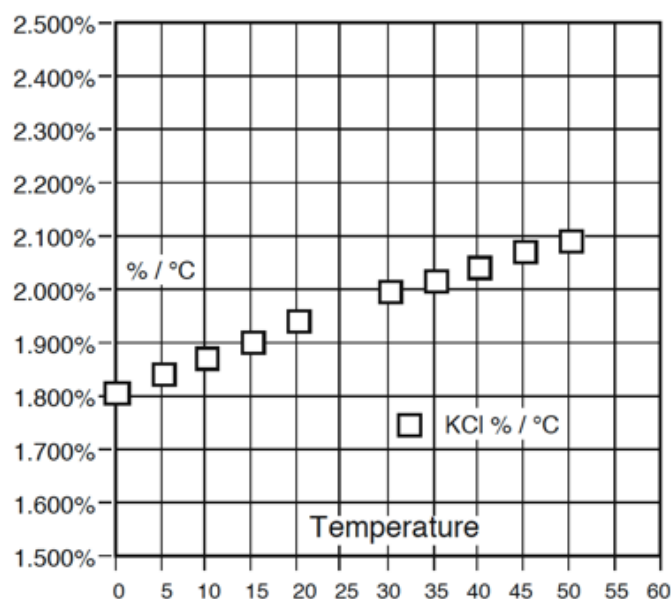

Chart 1

3. Example of 2 Different Solution Selections and the Resulting Compensation

How much error results from treating natural water as if it were KCl at 15°C?

A tap water solution should be compensated as 442 with a tempco of 1.68 %/°C, where the KCl value used would be 1.90 %/°C.

Suppose a measurement at 15°C/59°F is 900 microsiemens of true uncompensated conductivity.

Using a 442 correction of 10 (degrees below 25) x 1.68% indicates the solution is reading 16.8% low. For correction, dividing by (.832) yields 1082 microsiemens as a compensated reading.

A KCl correction of 10 (degrees below 25) x 1.9% indicates the solution is reading 19% low. Dividing by (.81) yields 1111 microsiemens for a compensated reading. The difference is 29 out of 1082 = 2.7%.

4. Chart of Comparative Error

In the range of 1000 μ S, the error using KCl on a solution that should be compensated as NaCl or as 442, is illustrated in Chart 2.

Users wanting to measure natural water based solutions to 1% would have to alter the internal compensation to the more suitable preloaded “442” values or stay close to 25°C. Users who have standardized to KCl-based compensation may want to stick with it, regardless of increasing error as you get further from 25°C. The 900 will provide the repeatability and convertibility of data necessary for relative values for process control.

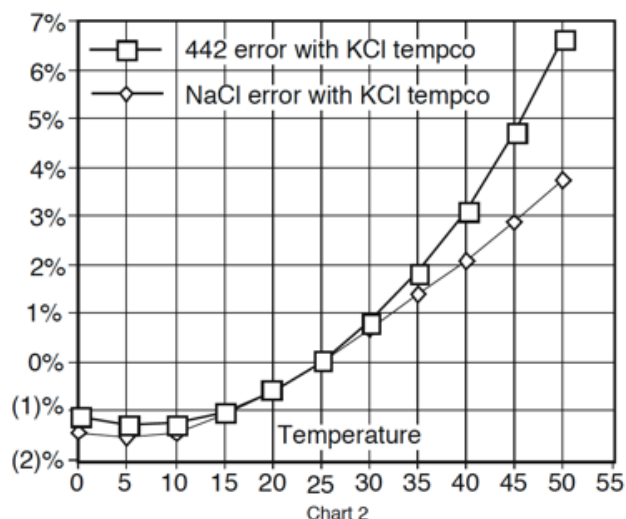

5. Other Solutions

A salt solution like seawater or liquid fertilizer acts like NaCl. An internal correction for NaCl can be selected for greatest accuracy with such solutions. Many solutions are not at all similar to KCl, NaCl or 442. A sugar solution, a silicate, or a calcium salt at a high or low temperature may require a User value unique for the application to provide readings close to the true compensated conductivity.

Clearly, the solution characteristics should be chosen to truly represent the actual water under test for rated accuracy of $\pm 1\%$. Many industrial applications have historically used relative measurements seeking a number to indicate a certain set point or minimum concentration or trend. The 900 gives the user the capability to collect data in “KCl conductivity units” to compare to older published data, in terms of NaCl or 442, or as appropriate. The 900 can be used to reconcile data taken with other compensation assumptions, especially with its ability to allow custom characteristics through the User mode.

B. Conductivity Conversion to Total Dissolved Solids (TDS)

Electrical conductivity indicates solution concentration and ionization of the dissolved material. Since temperature greatly affects ionization, conductivity measurements are temperature dependent and are normally corrected to read what they would be at 25°C (see REFERENCE INFORMATION/Temperature Compensation (Tempco) of Aqueous Solutions, page 84).

1. How it's Done

Once the effect of temperature is removed, the compensated conductivity is a function of the concentration (TDS). Temperature compensation of the conductivity of a solution is performed automatically by the internal processor with data derived from chemical tables. Any dissolved salt at a known temperature has a known ratio of conductivity to concentration. Tables of conversion ratios referenced to 25°C have been published by chemists for decades.

2. Solution Characteristics

Real world applications have to measure a wide range of materials and mixtures of electrolyte solutions. To address this problem, industrial users commonly use the characteristics of a standard material as a model for their solution, such as KCl, which is favored by chemists for its stability.

Users dealing with seawater, etc., use NaCl as the model for their concentration calculations. Users dealing with freshwater work with mixtures including sulfates, carbonates and chlorides, the three predominant components (anions) in freshwater that the Myron L® Company calls “Natural Water”. These are modeled in a mixture called “442™” which the Myron L® Company markets for use as a calibration standard, as it does standard KCl and NaCl solutions.

The 900 contains algorithms for these 3 most commonly referenced compounds. The solution type in use is displayed on the bottom left of the “Detailed Operating Screen”. Besides KCl, NaCl, and 442, the 900 offers a “User” (user adjusted tempco) option. The benefit of the User solution type is that one may enter a temperature compensation unique to their application, greatly increasing accuracy of readings for a specific solution. That value remains a constant for all measurements on the selected input channel and should be reset for different dilutions or temperatures.

3. When does it make a lot of difference?

First, the accuracy of temperature compensation to 25°C determines the accuracy of any TDS conversion. Assume we have industrial process water to be pretreated by RO. Assume it is 45°C and reads 1500 µS uncompensated.

1. If NaCl compensation is used, an instrument would report 1035 µS compensated, which corresponds to 510 ppm NaCl.
2. If 442 compensation is used, an instrument would report 1024 µS compensated, which corresponds to 713 ppm 442.

The difference in values is 40%.

In spite of such large error, some users will continue to take data in the NaCl Mode because their previous data gathering and process monitoring was done with an older NaCl referenced device.

Selecting the correct Solution Type on the 900 will allow the user to attain true TDS readings that correspond to evaporated weight. If none of the 3 standard solutions apply, the User Mode must be used. Temperature Compensation (Tempco) and TDS Derivation below, details the User Mode.

C. Temperature Compensation (Tempco) and TDS Derivation

The 900 contains internal algorithms for characteristics of the 3 most commonly referenced compounds. The solution type in use is displayed on the bottom left of the “Detailed Operating Screen”. Besides KCl, NaCl, and 442, there is the “User” Mode. The benefit of User Mode is that you may enter a unique temperature compensation factor (Tempco) for application specific solutions.

1. Conductivity Characteristics

When taking conductivity measurements, the Solution Selection determines the characteristic assumed as the instrument reports what a measured conductivity would be if it were at 25°C. The characteristic is represented by the tempco, expressed in %/°C. If a solution of 100 µS at 25°C increases to 122 µS at 35°C, then a 22% increase has occurred over this change of 10°C. The solution is then said to have a tempco of 2.2 %/°C.

Tempco always varies among solutions because it is dependent on their individual ionization activity, temperature and concentration. This is why the 900 features mathematically generated models for known salt characteristics that also vary with concentration and temperature.

2. Finding the Tempco of an Unknown Solution

You may need to measure compensated conductivity of solutions unlike any of the 3 standard salts. In order to enter a custom fixed tempco for a limited measurement range, enter a specific value through the User Mode function. The tempco can be determined by 2 different methods:

NOTE: This can be performed using the 900, or an easier method is to use a precision handheld instrument like the Ultrameter II.

1. Heat or cool a sample of the solution to 25°C and measure its conductivity. Heat or cool the solution to a typical temperature where it is normally measured. After selecting User Mode solution type, set the tempco to 0 %/°C. Measure the new conductivity and the new temperature. Divide the % decrease or increase by the 25°C value. Divide that difference by the temperature difference.
2. Heat or cool a sample of the solution to 25°C and measure its conductivity. Change the temperature to a typical measuring temperature. Set the tempco to an expected value. See if the compensated value is the same as the 25°C value. If not, raise or lower the tempco and measure again until the 25°C value is read.

3. Finding the TDS Ratio of an Unknown Solution

Once the effect of temperature is removed, the compensated conductivity is a function of the concentration (TDS).

There is a ratio of TDS to compensated conductivity for any solution, which varies with concentration. The ratio is set in TDS User Mode settings (see page 66).

A truly unknown solution has to have its TDS determined by evaporation and weighing. Then the solution whose TDS is now known can be measured for conductivity and the ratio calculated. This ratio can be entered into the custom conductivity to TDS ratio.

D. pH, ORP and Temperature Relationships

1. pH

a) pH as an Indicator

pH is the measurement of acidity or alkalinity of an aqueous solution. It is also stated as the hydrogen ion activity of a solution. pH measures the effective, not the total, acidity of a solution.

A 4% solution of acetic acid (pH 4, vinegar) can be quite palatable, but a 4% solution of sulfuric acid (pH 0) is a violent poison. pH provides the needed quantitative information by expressing the degree of activity of an acid or base. In a solution of one known component, pH will indicate concentration indirectly. However, very dilute solutions may be very slow reading, just because the very few ions take time to accumulate.

b) pH Units

The acidity or alkalinity of a solution is a measurement of the relative availabilities of hydrogen (H⁺) and hydroxide (OH⁻) ions. An increase in (H⁺) ions will increase acidity, while an increase in (OH⁻) ions will increase alkalinity. The total concentration of ions is fixed as a characteristic of water, and balance would be 10⁻⁷ mol/liter (H⁺) and (OH⁻) ions in a neutral solution (where pH sensors give 0 voltage).

pH is defined as the negative logarithm of hydrogen ion concentration. Where (H⁺) concentration falls below 10⁻⁷, solutions are less acidic than neutral, and therefore are alkaline. A concentration of 10⁻⁹ mol/liter of (H⁺) would have 100 times less (H⁺) ions than (OH⁻) ions and be called an alkaline solution of pH 9.

c) The pH Sensor

The active part of the pH sensor is a thin glass surface that is selectively receptive to hydrogen ions. Available hydrogen ions in a solution will accumulate on this surface and a charge will build up across the

glass interface. The voltage can be measured with a very high impedance voltmeter circuit; the dilemma is how to connect the voltmeter to solution on each side.

The glass surface encloses a captured solution of potassium chloride, holding an electrode of silver coated with silver chloride. This is as inert a connection as can be made from metal to an electrolyte. It still can produce an offset voltage, but using the same materials to connect to the solution on the other side of the membrane allows the 2 equal offsets to cancel.

The problem is the other side of the membrane is some test solution, not potassium chloride. The outside electrode, also called the reference junction, is of the same construction with a porous plug in place of a glass barrier to allow the junction fluid to contact the test solution without significant migration of liquids through the plug material. Migration does occur, and this limits the lifetime of a pH junction, from depletion of solution inside the reference junction or from contamination.

d) The Myron L[®] pH Sensor

The pH sensors for the 900 Series Monitor/Controllers are a single construction in an easily replaceable package. The sensor body holds a large solution supply for long life. The reference junction “wick” is porous to provide a very stable, low permeability interface. It is located under the glass pH sensing electrode. The construction combines all the best features of any pH sensor known.

e) Sources of Error

1. Reference Junction

The most common sensor problem is usually a clogged junction. The symptom is a drift in the “zero” setting at 7 pH. This is why the monitor/controller does not allow more than 1 pH unit of offset during calibration. At that point the junction is unreliable.

2. Sensitivity Problems

Sensitivity is the receptiveness of the glass surface, which can be diminished by a film on the surface, or a crack in the glass. These problems also cause long response time.

3. Temperature Compensation

pH sensor glass changes its sensitivity slightly with temperature. The further from pH 7 one is, the more effect will be seen. A pH of 11 at 40°C would be off by 0.2 units. The sensor measures the solution temperature, sends the data to the monitor/controller, which compensates the reading.

2. ORP/Oxidation-Reduction Potential/REDOX

a) ORP as an Indicator

ORP is the measurement of the ratio of oxidizing activity to reducing activity in a solution. It is the potential of a solution to give up electrons (oxidize other things) or gain electrons (reduce). Like acidity and alkalinity, the increase of one is at the expense of the other, so a single voltage is called the Oxidation-Reduction Potential, with a positive voltage showing, a solution wants to steal electrons (oxidizing agent). Chlorinated water will show a positive ORP value, for instance.

b) ORP Units

ORP is measured in millivolts, with no correction for solution temperature. Like pH, it is not a measurement of concentration directly, but of activity level. In a solution of only one active component, ORP does indicate concentration. Also, as with pH, a very dilute solution will take time to accumulate a readable charge.

c) The ORP Sensor

An ORP sensor uses a small platinum surface to accumulate charge without reacting chemically. That charge is measured relative to the solution, so the solution “ground” voltage comes from a reference junction - same as the pH sensor uses.

d) The Myron L[®] ORP Sensor

The ORP sensors for the 900 Series Monitor/Controllers are a single construction in an easily replaceable package. The sensor body holds a large solution supply for long life. The reference junction “wick” is

porous to provide a very stable, low permeability interface. It is located under the platinum sensing electrode. The construction combines all the best features of any ORP sensor known.

Both pH and ORP will indicate 0 for a neutral solution. Calibration at zero compensates for error in the reference junction.

e) Sources of Error

Sources of error are much the same as for pH. Though the platinum surface will not break like the glass pH surface, its protective glass sleeve can be broken. A surface film will slow the response time and diminish sensitivity. It can be cleaned off with IPA, detergent, or acid, as with the pH glass.

3. pH and ORP SENSOR CAUTIONS

Leaving high pH (alkaline) solutions in contact with the pH and/or ORP sensor for long periods of time can damage it. Samples containing chlorine, sulfur, or ammonia can “poison” any pH electrode. Any sample element which will reduce (add an electron to) silver, such as cyanide, will attack the reference electrode. Fluorides in the water will reduce the life of any pH sensor.

Our unique line of pH and ORP sensors are a non-refillable combination type featuring a porous liquid junction. It should not be allowed to dry out in use or in storage. If it does, the sensor can sometimes be rejuvenated by first cleaning the sensor with isopropyl alcohol then rinsing well. Do not scrub or wipe the sensor.

After you have cleaned the sensor with isopropyl alcohol, then use one of the following methods:

1. Soak the sensor in a HOT salt solution ~60°C (140°F), preferably potassium chloride (KCl) solution – HOT tap water with table salt (NaCl) will work fine – and allow to cool. Retest.
- or –
2. Soak the sensor in deionized water for no more than 4 hours (longer can deplete the reference solution and damage the glass bulb). Retest.

If neither method is successful, the sensor must be replaced.

“Drifting” can be caused by a film on the pH sensor bulb. Isopropyl alcohol may be used to clean the sensor. The sensor bulb is very thin and delicate. Do not scrub or wipe the sensor.

Replacement sensors are available only from the Myron L® Company or its authorized distributors.

E. Relay and Alarm Trigger, Set Point and Hysteresis Functionality

Trigger options are:

- Falling: The relay/alarm triggers if measurement falls below the set point.
- Rising: The relay/alarm triggers if measurement rises above the set point.
- In Window: The relay/alarm triggers if measurement goes within the set point window (below the high set point or above the low set point).
- Out Window: The relay/alarm triggers if measurement goes outside the set point window (above the high set point or below the low set point).

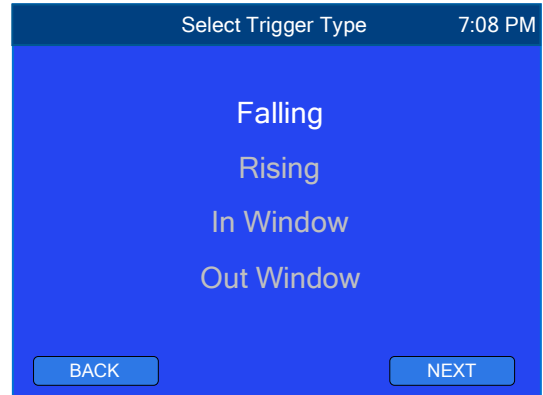

While setting up relay(s) and/or alarm(s), you will be required to set hysteresis values for each set point. By tapping the **DEFAULT** button, the 900 will automatically enter the default hysteresis values (100 mV for ORP, or 5% of the set point value for all other measurement types). Alternatively, you may enter custom hysteresis values for any or all set points. The hysteresis ranges are: 2-100 mV for ORP, or 0.30 to 5.00% of set point value for all other measurement types. Entering hysteresis values beyond the specified range will result in an ERROR message.

In the examples below, the process line colors indicate the LED and associated input channel's LCD background color.

NOTE: All relay(s)/alarm(s) and/or output signals associated with an input channel will be disabled if the measurement type for that input channel is changed or the input channel is disabled.

Examples of relays controlling pumps with different triggers:

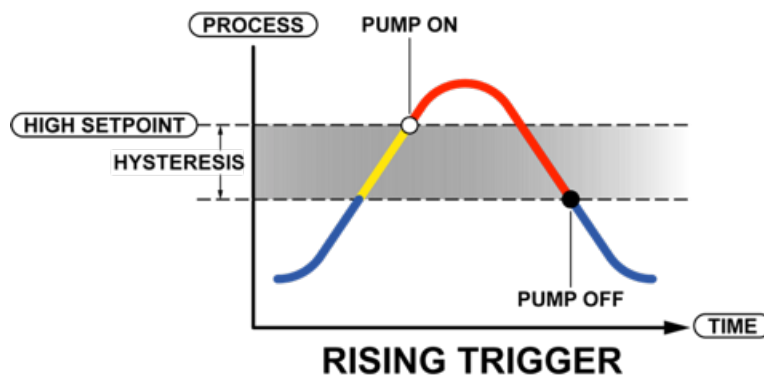
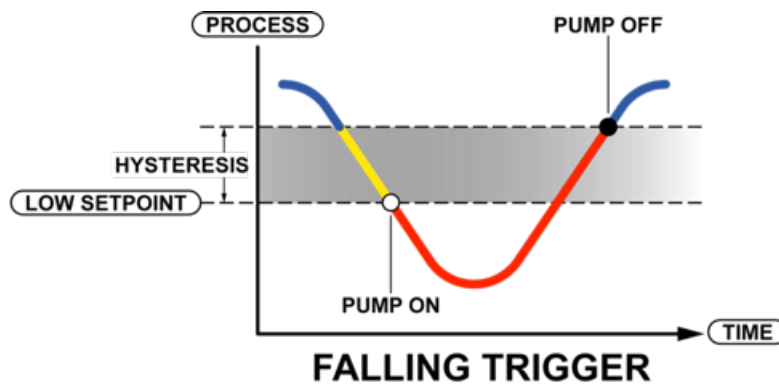

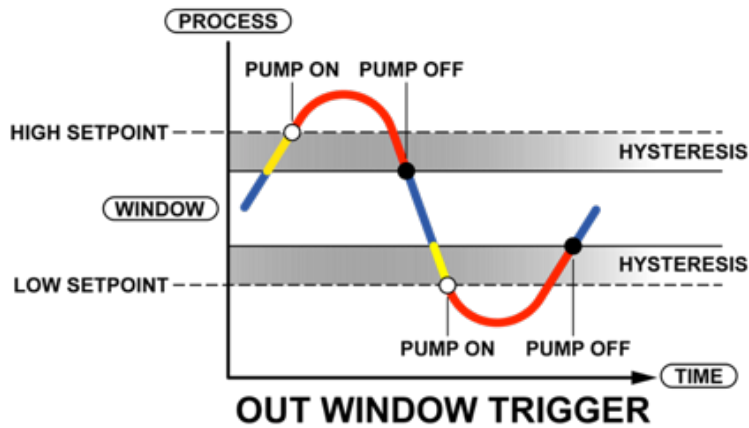
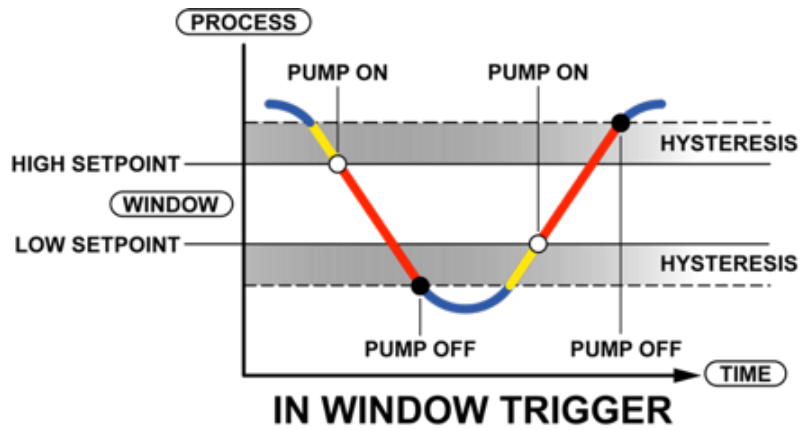

CAUTION	Adjusting the hysteresis too narrow may cause the status to fluctuate (on-off) due to flow, chemical mixing or bubbles causing the relay to chatter. This condition is to be avoided, as it could damage your valves, pumps, etc.... and will eventually damage the relay.
----------------	--

Example of relay “Chatter” caused by a hysteresis setting that is too narrow:

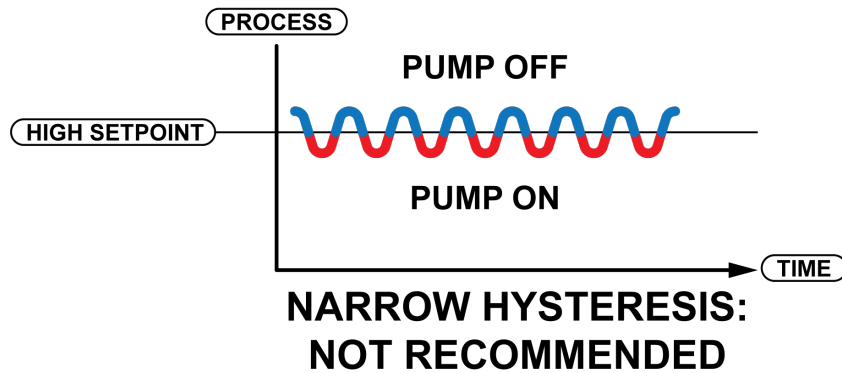

XIII. MAINTENANCE

A. 900 Series Multi-Parameter Monitor/Controller Base Unit

1. Cleaning the Display
 - It is recommended to disconnect the unit’s mains power prior to cleaning.
 - Use a soft dry cloth when cleaning the touchscreen.
 - Avoid using any chemical agents to clean the touchscreen.
 - Do not spray cleaning agents directly onto the touchscreen.
 - If using a mild cleaner, spray the cleaner on the cloth and then wipe the touchscreen with the cloth.
 - Use gentle wiping motions. Do not wipe or press the touchscreen with excessive force.
 - Do not use sharp tools to clean the surface of the touchscreen.
 - Do not use air guns, water jets, or steam, to clean the surface of touchscreens as they may damage touchscreen functionality.
 - Never use abrasive cleaners, waxes, or solvents to clean the touchscreen.
2. Calibrating the Display Touch Screen

Ordinarily you will never need to calibrate the touch screen, however, if the touch screen buttons do not respond to direct contact, the touch screen may have lost calibration. To re-calibrate the display touch screen, you will need a small stylus or something with a small rounded tip that will not harm the touch screen.

1. Turn the 900’s power supply off.
2. Press and hold the center of the screen and turn the 900’s power supply back on.
3. Release the screen.
4. Tap the center of the center of screen to begin calibration.
5. Using a small stylus for exact placement:
 - a. Tap the center of the small dot on the top left side of the screen.
 - b. Tap the center of the small dot on the top right side of the screen.
 - c. Tap the center of the small dot on the bottom right side of the screen.
 - d. Tap the center of the small dot on the bottom left side of the screen.
6. Tap the center of the screen to accept calibration and return to normal operating mode.

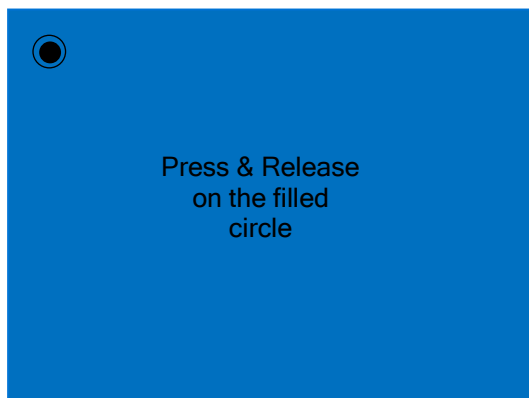

B. Sensor Care

Myron L® Company recommends cleaning and calibrating sensors regularly. Frequency depends on your application.

	<p>Myron L® Company recommends a regular program for calibrating and/or verifying the proper operation of all sensors to avoid sensor failure affecting the accuracy or reliability of the 900 Monitor/Controller.</p> <ul style="list-style-type: none"> • This is particularly important for pH sensors, which have a limited life span.
---	---

1. pH and ORP Sensors

Periodically remove, clean and inspect the sensor. pH and ORP sensors may be cleaned using Isopropyl Alcohol (IPA). This will remove oils that have saturated into the glass bulb and on the surface of the reference junction.

If the process will not allow sufficient down time, replace sensor with another, and clean using the procedure below. Periodic cycling of sensors may be necessary due to the process.

Another effective, but less friendly method is to use 5% HCl acid. This is harsh on the sensor and can be dangerous to personnel. And it is usually not necessary unless there is excess scaling.

Depending on application, soaking in a detergent containing enzymes is also an effective method to clean the sensor.

Try the IPA first.

For ORP sensors we have found, after IPA cleaning, lightly polishing the Platinum tip with emery paper will help to restore the correct indication on the monitor/controller. Allow recovery time.

To clean a pH or ORP sensor:

1. Turn system OFF.
2. Carefully remove sensor from solution stream.
3. Rinse with clean water.
4. Shake dry.
5. Pour a small amount of IPA in to a beaker, glass, or cup.
6. Swish the sensor in the IPA for about 5 minutes.
7. Rinse again with clean water.
8. Shake dry.
9. Soak sensor in Myron L pH/ORP Storage Solution until sensor recovers from IPA cleaning shock.
10. Reinstall sensor in to system line with fresh thread sealant.
11. Turn system ON.

PLEASE NOTE THE FOLLOWING:

- ALL pH and ORP sensors have a limited life.
- Operating conditions; temperatures and solutions all have an effect on that life. The higher the temperatures and stronger the solutions, the shorter the life.
- When not in use or in storage, sensors must be hydrated at all times with Myron L® Company pH/ORP Sensor Storage Solution.
- Offset and gain characteristics may be compensated for by calibration.
- Calibration beyond ± 1 pH unit or ± 60 mV indicate sensor contamination or damage, sensor must be cleaned or replaced. Continued use beyond these limits could affect your system's accuracy and reliability.

2. Conductivity, TDS, Resistivity, and Salinity Sensors

Periodically remove, clean and inspect the sensor.

To clean a conductivity, TDS, resistivity, or salinity sensor with an oily film:

1. Turn system OFF.
2. Carefully remove sensor from solution stream.
3. Clean the sensing electrode with soapy water.
4. Rinse with clean water.
5. Shake dry.
6. Reinstall sensor in to system line with fresh thread sealant.
7. Turn system ON.

To clean a conductivity, TDS, resistivity, or salinity sensor with a calcium buildup:

1. Turn system OFF.
2. Carefully remove sensor from solution stream.
3. Rinse with clean water.
4. Shake dry.
5. Soak the sensor in white vinegar for about 5 minutes.
6. Rinse with clean water.
7. Shake dry.
8. Reinstall sensor in to system line with fresh thread sealant.
9. Turn system ON.

XIV. TROUBLESHOOTING

A. Troubleshooting Chart

Symptom	Possible Cause	Remedy
No display	Unit is not getting power.	<ol style="list-style-type: none"> 1. Ensure power supply is connected properly. 2. Ensure power supply is turned on.
Display is dim	<ol style="list-style-type: none"> 1. Display has a low “Brightness” setting. 2. Display is in Night Mode. 	<ol style="list-style-type: none"> 1. Adjust display brightness in Settings / Display / Brightness. 2. Disable or adjust Night Mode in Settings / Display / Night Mode.
Touch screen buttons do not work	Touch screen calibration is off.	Calibrate the touch screen.
Cannot display desired input channel	Input channel has not been enabled.	Enable input channel in Settings / System / Input Channel.
Cannot disable COND/RES1 or COND/RES2 input channels	% Rejection is enabled.	Disable % Rejection.
Cannot enable % Rejection	Both COND/RES1 and COND/RES2 input channels are not enabled.	Enable and set up COND/RES1 and COND/RES2 input channels.
Relay/alarm icon showing up on an operating screen after I disabled the relay/alarm	The relay/alarm was set up and linked to the input channel.	Reset the relay/alarm.
pH value is dashed out on mV input channel	pH (with temperature compensation) is selected as the measurement type and there is no temperature signal.	Verify RTD sensor is good, connected properly, and the RTD input channel is enabled.
Readings are not as expected	<ol style="list-style-type: none"> 1. Sensor is dirty or needs calibration. 2. Incorrect measurement type or solution type is selected. 	<ol style="list-style-type: none"> 1. Clean sensor and recalibrate. 2. Verify desired measurement type and solution type are selected.

B. Frequently Asked Questions

Question: Why is the relay/alarm icon showing up on a measurement screen even after I disabled the relay/alarm?

Answer: Once a relay or alarm is set up and linked to an input channel, it will stay linked so you can easily re-enable it or until you link it to another input channel. To remove the link, simply reset the relay/alarm, see “Relay/Alarm Settings Reset”, page 50.

Question: Why are the pH and ORP readings incorrect when I hook up a millivolt generator?

Answer: The pH/ORP input channel is intended for use with Myron L[®] Company pre-amplified pH and ORP sensors. These sensors contain precision circuitry that increases the accuracy and permits application of the sensors over greater distances. This pre-amp circuitry affects the gain. If you wish to verify the circuitry using a millivolt generator, you should change the sensor type from “MLC pH” or “MLC ORP” to “Generic”.

Question: Why does the pH 7 reading change when I go into Calibration Mode?

Answer: The uncalibrated (raw) pH value will be displayed while the 900 is in pH 7.00 calibration. This will assist in determining the accuracy of the pH sensor. If the pH reading is above 8 or below 6 with the

sensor in pH 7 buffer solution, the sensor needs additional rinsing, the sensor needs to be cleaned, or the pH sensor is defective and needs to be replaced.

C. System Overview Screen

The System Overview screen is a temporary version of the All Channels operating screen. This feature allows you to view all inputs with their current readings, as well as outputs with their status . . . without changing the screen layout.

Quick access features available from this screen are:

- Tapping an input field will bring you to the associated input’s “Detailed Operating Screen”.
- Tapping an output field will bring you to the associated output’s setup screen.
- Tapping a disabled input channel (text is gray) will bring you to the “Select Input Channel” screen (where you can enable/disable any or all input channels).

NOTE: When the “Display Timeout” is enabled, and the display times out, the screen will return to normal operating mode.

To put the 900 into “System Overview” from any “Detailed Operating Screen”:

1. Tap the **ADJUST** button to enter EDIT Mode.
2. Tap the **SETTINGS** button.
3. Tap the System Overview field.

To exit the System Overview simply tap the **BACK** button.

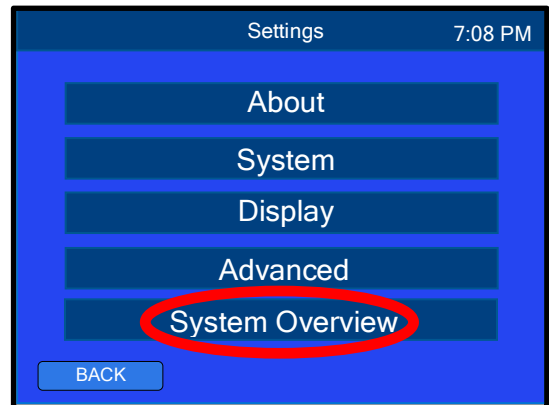

Inputs		Outputs	
COND/RES1	- - - μS	0-10V	7.87 V
COND/RES2	284.6 μS	4-20mA	4.00mA
pH/ORP	7.16	Relay 1	Off
mV IN	835.7 mV	Relay 2	On
RTD	23.2 °C	Relay 3	Off
4-20mA IN	13.45 mA	Alarm 1	Off
FLO/PULSE	1.45 gps	Alarm 2	Disabled

At the bottom left of the table area is a 'BACK' button.

System Overview

XV. ACCESSORIES**CAUTION**

CAUTION	Use only manufacturer provided parts or accessories as instructed in the operation manual, and do not use un-authorized parts or accessories for the equipment.
----------------	---

A. Standard Solutions and Buffers**1. Conductivity/TDS Standard Solutions**

Your 900 Series Monitor/Controller conductivity/TDS has been factory certified to meet certain specifications based on the appropriate Myron L[®] Company NIST traceable standard solutions. These same solutions are available to you.

The Myron L[®] Company manufactures three basic types of Conductivity/TDS Standard Solutions — KCl, NaCl and 442™. See below.

Most Myron L[®] standard solution bottles show three values referenced at 25°C: Conductivity in microsiemens/micromhos, while the ppm/TDS equivalents are based on our 442 Natural Water™, and NaCl standards. All standards are within ±1.0% of reference solutions.

These same standard solutions may be used for calibration and recertification of your 900 Series Multi-Parameter Monitor/Controller.

a) Potassium Chloride (KCl)

The concentrations of these reference solutions are calculated from data in the International Critical Tables, Vol. 6.

b) 442 Natural Water™

442 Natural Water Standard Solutions are based on the following salt proportions: 40% sodium sulfate, 40% sodium bicarbonate, and 20% sodium chloride which represent the three predominant components (anions) in freshwater. This salt ratio has conductivity characteristics approximating fresh natural waters and was developed by the Myron L[®] Company over five decades ago. It is used around the world when measuring both conductivity and TDS in drinking water, ground water, lakes, streams, etc.

c) Sodium Chloride (NaCl)

This is especially useful in seawater mix applications, as sodium chloride is its major salt component. Most Myron L[®] standard solution labels show the ppm NaCl equivalent to the conductivity and to ppm 442 values.

2. pH and ORP Buffer Solutions

The pH and ORP requires the same care and calibration as your Conductivity/TDS. With the following Myron L[®] Company pH buffer solutions and ORP standard solutions it is possible for you to maintain the accuracy required in your process.

These same buffers may be used for calibration and recertification of your Myron L[®] or other handheld instruments.

a) pH Buffer Solutions

NIST traceable pH buffers are available in 4.00, 7.00 and 10.00 pH. Myron L[®] Company buffer solutions are traceable to NIST certified pH references and are color-coded for instant identification. They are also mold inhibited and accurate to within ±0.01 pH units @ 25°C. Available in 2 oz., quarts/liters, and gallon/~3.8 liter bottles.

b) ORP Standard Solutions

Myron L[®] Company offers ORP Standard Solutions in the values of 80mV Quinhydrone, 260mV Quinhydrone, or 470mV MLC Light's ORP solution. See *ORP Calibration Kit* for more information.

c) pH/ORP Sensor Storage Solution

Myron L® pH/ORP Sensor Storage Solution prolongs the life of the pH/ORP sensor while not in use. It is available in quarts and gallons. Order SSQ, SSG or SS2OZ.

3. Ordering Information

NOTE: Solution part numbers end with the size identifier; G: Gallon, Q: Quart, 2OZ: 2 Ounce, or 1OZ: 1 Ounce (ORP470 only).

Order example: 442-3000Q (442-3000, 1 quart)
 KCl-7000G (KCl-7000, 1 gallon)
 PH102OZ (pH 10.00, 2 ounce)
 ORP4701OZ (ORP 470, 1 ounce)

Potassium Chloride Standards

KCl-18
 KCl-180
 KCl-1800
 KCl-18,000
 KCl-70
 KCl-700
 KCl-7000
 KCl-70,000

442 Natural Water Standards

442-15
 442-150
 442-1500
 442-15,000
 442-30
 442-300
 442-3000
 442-30,000
 442-500
 442-1000

Sodium Chloride Standards

NaCl-12.5
 NaCl-13.4
 NaCl-14.0
 NaCl-7500

pH Buffer Solutions

PH4.00
 PH7.00
 PH10.00

ORP Standard Solutions

ORP80 (available in 2 ounce, and multi-packs)
 ORP260 (available in 2 ounce, and multi-packs)
 ORP470 (available in 1 ounce)

pH/ORP Storage Solution

SSQ - Quart/liter
 SSG - Gallon
 SS2OZ - 2 Ounce.

Customer-specific Standard Solutions are available by special order. Contact the Myron L® Company or your local distributor for more information.

B. NIST Certification

NIST Certificates are available by quote, contact the Myron L® Company Technical Sales.

Myron L® Company offers certificates indicating product conformity to relevant requirements in standards and regulations established by the National Institute of Standards and Technology, a non-regulatory agency within the US Commerce Department's Technology Administration.

C. Resistivity Sensor Substitutes

900 SERIES RESISTIVITY SENSOR SUBSTITUTE	
VALUE	ORDER PART NUMBER
20 MΩ	CS9-11

D. Temperature Sensor Substitutes

Contact the Myron L® Company Technical Sales.

E. Alarms

1. Terminal Block Locations

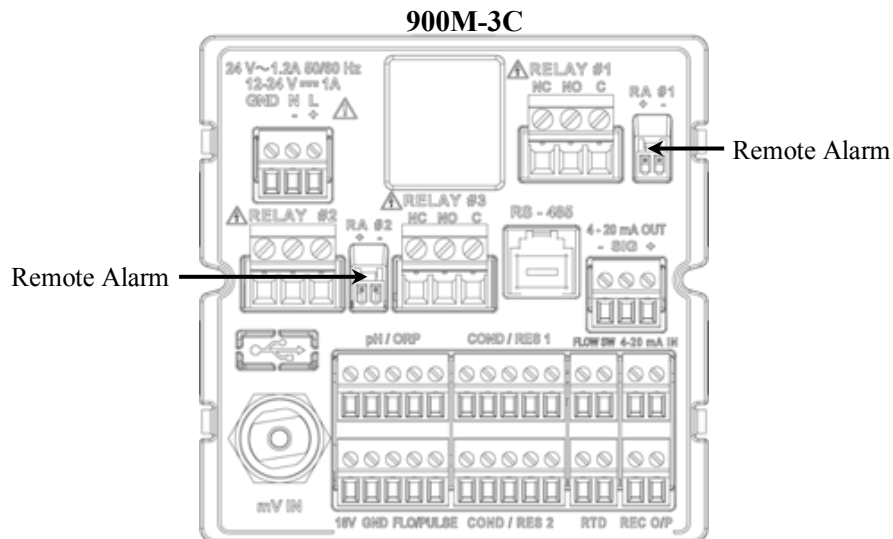

2. Remote Alarm - RA™

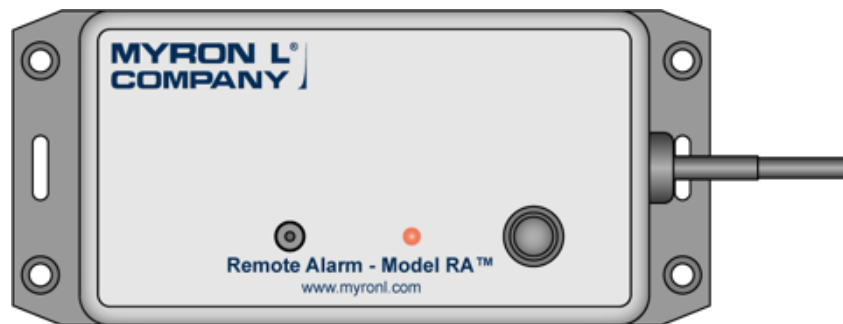

IMAGES NOT TO SCALE

a) Description

This remotely mounted AUDIBLE and VISUAL alarm connects to any Myron L® Company Monitor/Controller, or brand “X” controller with dry contacts. When activated by the 900 the Remote Alarm will provide both an audible and a visual alert at a remote location as well as the visual warnings at the monitor/controller.

A mute button will silence the piezo alarm for up to 10 minutes while the LED remains illuminated. After the preset time the piezo alarm will again sound, this will repeat until the alarm condition is corrected. Thus allowing servicing of the system under control, while still acting as a reminder if the problem has not been corrected. Installation is simple; only 2 wires to connect from the controller to the RA, set the time, and mount it on the wall or on a bench.

The Remote Alarm - RA™ is an inexpensive way to alert personnel of a trouble situation. For example; the monitor/controller may be located with an RO system while the service technicians are on another floor or even in another building. The AUDIBLE alarm may be silenced but stays in alarm mode (RED LED is still illuminated) until the trouble is corrected. The timer may be set from 15 seconds up to 10 minutes, thereby, giving personnel the time to correct the problem while not being able to ignore the trouble because of the reoccurring AUDIBLE and VISUAL alerts.

Order Part #	Description
RA	Remote Alarm™
RAH	Replacement Harness, female connector w/12" 2 conductor wire. For use w/ RA or PA
RAW-200	Wire, 200 feet/61 meters for Remote Alarm or Piezo Electric Alarm

b) Specifications

Audible Alert – Piezo Electric

- Oscillating Frequency – 3.0 ± 0.5 kHz
- Operating Voltage – 24 VDC Nom. (1.5 – 30 VDC Max.)
- Sound Pressure Level (Min) 30 cm/12 VDC – 80 dB
- Current consumption (Max) 12 mA @ 12 VDC (20 mA @ 24 VDC)
- Tone – Constant
- Operating Temperature – -20 to +60°C
- Size – 24 x 9.5 mm

Visual Alert – Bright RED LED

- Time Delay – 15 seconds to 10 minutes (USER adjustable)
- Power – 24 VDC (supplied from Monitor/Controller)
- Case Material – ABS plastic
- IP Rating – N/A
- Dimensions – 5.72 L x 2.56 W x 1.56 H (145 L x 65 W x 40 H)
- Mounting – Customer supplied screws
- Operational Distance – Wire lengths of 500 feet (152 meters) have been tested with no adverse effects
- Includes 12" harness with connector, and two (2) wire nuts.
- Additional Wire available, order RAW-200. – 200 feet (61 meters)

c) Installation

The Remote Alarm - RA connector (part #RAH) has 12-inch 2-conductor wires attached – Black is Positive (+) and White is Negative (-).
 When extending the wires, you may use any 2-color wire you wish, just verify the polarity – Black is Positive (+) and White is Negative (-). Wire lengths of 500 feet/152 meters have been tested and have no adverse effect on performance.
 Ensure the unit is completely wired, tested and adjusted before installing RA to mounting surface.

Remote Alarm Harness

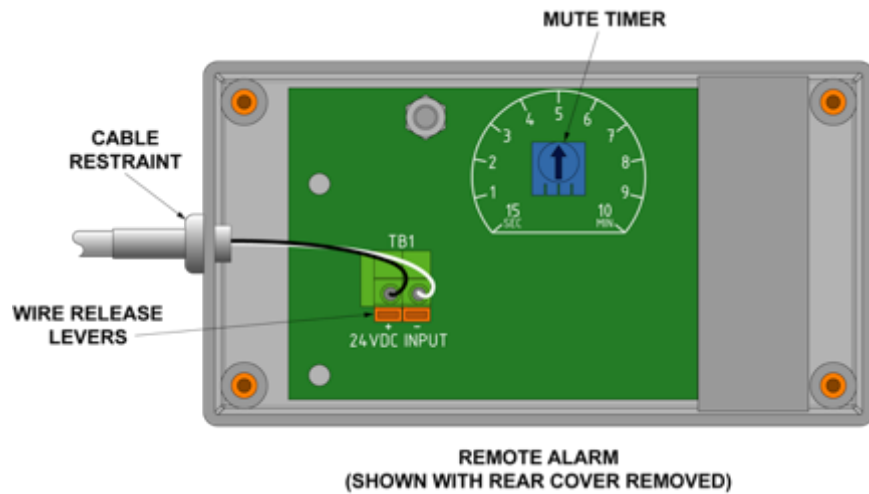
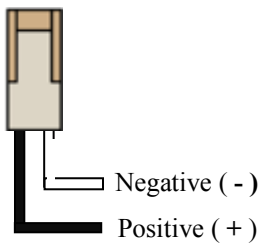

1. Run #22, 2-conductor speaker type wire (NOT supplied) from Monitor/Controller to RA location as necessary (wire insulation should be stripped back approximately 0.2" on both ends. Wire may be ordered from the Myron L® Company, part #RAW-200.

2. Connect the extension wire to the RA:
 - a. Open the RA by removing the four (4) screws on the back and removing the rear cover.
 - b. Remove the cable restraint from the side of the RA housing.
 - c. Run the extension wire thru the side of the RA housing.
 - d. Connect the extension wires to the connector on the RA circuit board — Black to Positive (+) and White to Negative (-).

 CAUTION	<p>The RA connectors require only a small screwdriver or a pen to push on the release levers. The release levers may be broken or damaged if not pushed straight toward the circuit board. DO NOT push the release levers sideways.</p>
---	--

- e. Install the cable restraint on the wire and insert into the side of the RA enclosure.
3. Adjust the mute timer on the RA circuit board to desired time from 15 seconds to 10 minutes by turning the small dial.
4. Connect the RA to the 900:
 - a. Connect the monitor/controller end of the extension wires to the 12-inch 2-conductor wire harness with the wire nuts provided — Black to Positive (+) and White to Negative (-).
 - b. Plug the RA connector into the RA #1 or RA #2 connector on the back of the 900 Series Monitor/Controller.
5. Test to verify the RA sounds when triggered by using the Test feature, see “Testing Relays and Alarms” on page 49.
6. Replace the bottom of the RA and secure it to the surface you have selected or set on a bench.

NOTE: If the RA does not sound off:

1. Check the polarity of the extension wire connections.
2. Be sure the alarm is enabled and set up properly.

3. Piezo Electric Alarm

The PAO is an electronic sound device capable of emitting an 80 dB or more @ 30 cm, high pitched squeal.

Order Part #	Description
PAO	80dB Piezo Electric Alarm
RAH	Replacement Harness, female connector w/12” 2 conductor wire. For use w/ RA or PA
RAW-200	Wire, 200 feet/61 meters for Remote Alarm or Piezo Electric Alarm

- a) Specifications:
 - Oscillating Frequency — 3.0 ±0.5 kHz
 - Operating Voltage (900) — 1.5-30 VDC Max.
 - Sound Pressure Level (Min) 30 cm/12 VDC — 80 dB
 - Current consumption (Max) @ 12 VDC — 12 mA
 - Recommended 12 VDC, tested up to 22 VDC
 - Tone — Constant
 - Operating Temperature — -20 to +60°C
 - Piezo Alarm Body Size — 24 x 9.5 mm
 - IP Rating — N/A

Includes 12” harness with connector.

When extending the wires, you may use any 2-color wire you wish, just verify the polarity — Red is Positive (+) and Brown is Negative (-). Wire lengths of 500 feet/152 meters have been tested and have no adverse effect on performance.

Ensure the unit is completely wired, tested and adjusted before installing RA to mounting surface.
 Additional Wire available, order RAW-200. — 200 feet (61 meters)



b) Installation:

The PAO Piezo Alarm attaches to the back of a panel with the double-sided tape supplied. Mounting will require a .25" (6.35mm) hole and extending the harness. Use #22 gauge speaker wire. Observe polarity.

CAUTION: The Piezo Alarm (PA) is not waterproof. Installing this option requires a 1/4" hole for sound transmission. Installation inside an IP Rated enclosure will compromise the IP Rating.

1. Select mounting location.
 - a. If remotely mounted; cut wires and splice as necessary, use comparable wire.
2. Using a 1/4" drill, carefully drill a hole in the panel in desired location.
3. Peel off tape backing from Piezo Alarm, and install behind the panel, ensuring the center of the Piezo Alarm is centered over the hole in the panel.
4. Plug the Piezo Alarm's connector into connector location RA #1 or RA #2 on the back of the 900 Series Monitor/Controller.
5. Test to verify the Piezo Alarm sounds when triggered by adjusting the set point beyond the current reading value.

NOTE: If the Piezo Alarm does not sound off:

1. Check the polarity of the extension wire connections.
2. Be sure the alarm is enabled and set up properly.

4. Connecting to Your Own Alarm

Use the following as guidelines.

NOTE: Ensure your requirements do not exceed the 20 VDC Unregulated 20 mA maximum.

The Remote Alarm Harness (RAH) connector(s), included with your 900, are standard 2 wire Methode* style connector(s) with 12" wires and wire nuts.

1. Attach your alarm to the Remote Alarm Harness. Ensure the polarity is correct; Black is Positive (+) and White is Negative (-).
2. After you have attached the harness to your alarm, plug the harness into the desired input (RA #1 or RA #2) on the back of the 900.
3. Test to verify the alarm sounds when triggered by adjusting the set point beyond the current reading value.

Remote Alarm Harness

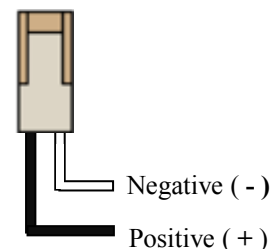

NOTE: If the alarm does not sound off:

1. Check the polarity of the extension wire connections.

Replacement Alarm Harnesses are available from the Myron L Company, order part #RAH.

*Methode is registered trademark of Methode Electronics, Inc.

F. Mounting Brackets

Order Part #	Description
9MBAPC	900 Mounting Bracket, Adapter for 700 Series Cutout, Aluminum, Powder Coat, Black
9MBHPC	900 Mounting Bracket, Horizontal, Aluminum, Powder Coat, Black
9MBVPC	900 Mounting Bracket, Vertical, Aluminum, Powder Coat, Black
Additional Mounting Hardware Available, Contact the Myron L [®] Company.	

G. Power Adapter

Order Part #	Description
PWRADAPT	900 Series Power Adapter, Input: 100-240 VAC, Output: 24 VDC, 1.7 A

1. Specifications

Input Voltage: 100-240 VAC
 Output Voltage: 24 VDC
 Output Current Max: 1.7 A

 WARNING	<p>This power adapter / supply has been tested by Myron L[®] Company to ensure that it provides adequate power to properly operate the 900 Series Multi-Parameter Monitor/Controller across the instrument's full operating temperature range. It has received UL (for US and Canada), GS, and PSE safety approvals for applications up to 40°C.</p> <p>To maintain the 900 Series Multi-Parameter Monitor/Controller IEC 61010-1 safety rating, only use an external power supply / adapter that is IEC/UL 61010-1 or IEC/UL 60950-1 rated to the full operating temperature range of the instrument (0°C to 60°C).</p>
--	---

XVI. GLOSSARY

442™	An Internationally recognized “natural water” standard developed by the Myron L® Company in 1964.
Algorithm	A procedure for solving a mathematical problem.
Anions	Negatively charged ions
DVM	Digital Volt Meter
Gal	gallon
gph	gallons per hour
gpm	gallons per minute
gps	gallons per second
Hysteresis	Dead Band – related to relay/alarm set point. The amount of delay or overlap between change from high to low or low to high.
Hz	hertz
K-factor Value	The number of pulses expected for every one volumetric unit of fluid passing through a given flow meter.
K-factor Unit	Volumetric unit of fluid passing through a given flow meter.
KCl	Potassium Chloride — used as a standard for many applications. Normally, micromhos or microsiemens are the units of measure.
kHz	kilohertz
kΩ	kilohm
LCD	Liquid Crystal Display
lph	liters per hour (l/hour)
lpm	liters per minute (l/min)
lps	liters per second (l/s)
Ltr	liter
mA	milliampere
mS	millisiemen
mV	millivolt
MΩ	megohm — common unit of measurement for resistivity.
NaCl	Sodium Chloride — used as a standard for sea water and other applications.
NIST	National Institute Standards & Technology
NTU	Nephelometric Turbidity Units
ppm	parts per million — common units of measure for TDS.
ppt	parts per thousand — common units of measure for TDS.
PSI	pounds per square inch
Pulse/Gal	pulses per gallon
Pulse/L	pulses per liter
TDS	Total Dissolved Solids or the Total Conductive Ions in a solution — normally displayed as ppm or ppt.
Tempco (TC)	Temperature Compensation

USP25	United States Pharmaceutical regulation, revision number 25. In part, requires conductivity, TDS, resistivity or pH measurements be taken, recorded and/or systems controlled using equipment without temperature compensation. Requires a separate temperature measuring device (temperature measurements may be part of conductivity, TDS, resistivity or pH device but must not correct measurements for temperature errors).
V	volt
μ S	microsiemens — common unit of measure for conductivity.
Ω	ohm
$^{\circ}$ C	degree Celsius
$^{\circ}$ F	degree Fahrenheit

XVII. WARRANTY

All Myron L[®] Company 900 Series Multi-Parameter Monitor/Controllers have a TWO Year Limited Warranty. If any Monitor/Controller fails to function normally, return the faulty unit to the factory prepaid. If, in the opinion of the factory, failure was due to materials or workmanship, repair or replacement will be made without charge.

A reasonable service charge will be made for diagnosis or repairs due to normal wear, abuse or tampering. Warranty is limited to the repair or replacement of Monitor/Controller only. The Myron L[®] Company assumes no other responsibility or liability.

Sensors and Accessories are sold separately and carry their own warranties.

Myron L® Company
2450 Impala Drive
Carlsbad, CA 92010-7226
USA

Tel: +1-760-438-2021

Fax: +1-760-931-9189

E-Mail: info@myronl.com

techquestions@myronl.com

www.myronl.com

Designed, Engineered and Assembled in the USA

ACCURACY • RELIABILITY • SIMPLICITY

